

Study

CO₂ reduction potential in European waste management



© AdobeStock - sodawhiskey-min / © iStock-Aimaflo

FOREWORD

Brussels, 24 January 2022 - The European Union has positioned itself front and centre in the fight against climate change and has set Europe on course to carbon neutrality by 2050. This ambitious objective set up by the Climate Law echoes the European Green Deal and Circular Economy action plan to transition Europe towards a resource efficient and climate neutral economy. The Waste management sector fully supports these necessary ambitions and responds today by quantifying the potential of avoided CO₂ emissions from activities along the entire waste management chain within the EU economy by 2035.

To begin this research FEAD formed a group with three other European Waste Management Associations: CEWEP, RDF Industry Group, and DWMA, fully representing the entire waste management chain from collection to recycling, recovery and disposal. Jointly they pursued the project of a unique study covering the EU27 and the UK to show the potential of improved waste management performances over the next 20 years.

Two renowned research organisations, Prognos and CE Delft were commissioned to carry out a study on nine specific waste streams and residual waste, that were deemed to have the highest potential in CO₂ reductions; the baseline used for the study are figures from 2018, amounting to 505 Mt of waste, equivalent to 20% of the waste generated in the EU.

The study showed in the end that the potential of avoided CO₂ emissions is truly impressive under two scenarios envisaged for 2035.

By successfully applying current waste legislation (projection 1), we would significantly improve our CO₂ avoidance potential to -137 Mt CO₂eq, delivering a saving of 150 Mt CO₂eq. With more ambitious performances (projection 2), the CO₂ net emission avoidance would reach -283 Mt CO₂eq, which would result in savings of 296 Mt CO₂eq.

These results consider the CO₂ savings from the manufacturing and energy sectors that rely on recyclates and waste-to-energy instead of virgin materials and fossil fuels.

To give a concrete order of magnitude, the net CO₂ avoidance potential in projection 1 represents nearly half of the emissions of Spain in 2019¹, and projection 2 represents ¾ of the emissions of Poland in 2019².

There can be no doubt that our sector plays a pivotal role in the EU's climate aspirations. This study clearly shows that climate challenges will require the full enforcement of EU legislation. As previously mentioned, Climate Law is one of the cornerstones of the EU Green Deal, and we strongly urge for current recycling and landfilling targets to be met. We also call on the EU legislator to set up stronger regulatory signals that would increase the demand for recyclates and trigger further investments from our industries in separate collection, sorting, and recycling facilities. Crucial to these processes are mandatory recycled content in products, strengthened ecodesign, positive Taxonomy rules for energy recovery, safe and efficient intra-EU waste shipments rules. Strong public support for selective collection will be decisive.

Our four associations representing the entire waste management chain are committed to these objectives through increased investments and performance to fully contribute to CO₂ savings, and to a more circular economy for Europe.

Peter Kurth

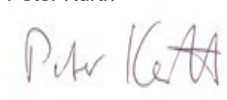

FEAD President



¹ Emissions of Spain in 2019: 333 Mt CO₂eq, Eurostat

² Emissions of Poland in 2019: 393 Mt CO₂ eq, Eurostat

Initiators of the Study

FEAD is the European Waste Management Association that represents private companies operating along the whole waste management chain across Europe. FEAD's objective is to advocate for a better regulatory framework for the waste management sector and to strengthen the circular economy in Europe.

www.fead.be



The Dutch Waste Management Association represents the national and international interests of waste companies active in the Netherlands. With more than 50 members, the DWMA is an important discussion partner for government, regional and local authorities, and other organizations.

www.verenigingafvalbedrijven.nl



CEWEP, Confederation of European Waste-to-Energy Plants, is the umbrella association of the operators of Waste-to-Energy (incineration with Energy Recovery) plants, representing about 410 plants from 23 countries. They make up more than 80% of the Waste-to-Energy capacity in Europe.

www.cewep.eu

The RDF Industry Group brings together organizations from across the European waste-derived fuel supply chain, providing a platform to address issues faced by the sector and to explore new opportunities. The Group currently has 33 members.

www.rdfindustrygroup.org.uk

Project Team



For over 60 years, Prognos has provided clients from enterprises, political institutions, and civil society with a sound foundation for decision making. This is achieved by independent research, consulting, and diagnosis. With our robust research, dependable reports, and competent expert opinions, we at Prognos support clients from the public and private sectors in developing future-proof strategies.

Our inter-disciplinary project teams comprised of dedicated economists, geographers, engineers, mathematicians, sociologists, and logistic researchers work in unison which ensures a constant ongoing exchange between our seven consulting fields: Economy & Labour, Society & State, Location & Region, Technology & Innovation, Energy & Climate Protection, Infrastructure & Transportation, and Management Consulting.

Prognos was the project leader of this project and worked on waste volumes and the overall CO₂ assessment.

Website: www.prognos.com

Contacts: Dr. Bärbel Birnstengel (baerbel.birnstengel@prognos.com)
Richard Simpson (richard.simpson@prognos.com)
Romy Kölmel (romy.koelmel@prognos.com)



CE Delft is an independent Dutch research and consultancy organization specialized in developing innovative and cutting-edge solutions to environmental problems. Established in 1978 as a not-for-profit organization, CE Delft remains financially independent and unsubsidized to this day. CE Delft employs around 70 sustainability experts in the areas of life-cycle assessment, environmental economics, circular economy, energy transition, mobility and transport, and (bio)fuels. Among the employees there's a fruitful interchange of expertise since everyone works at one location (Delft).

CE Delft has been providing technical support and policy analysis on waste policies, climate policies, market-based instruments, built environment and transport policies for over fifteen years to the European Commission, Member State Governments, industry and other stakeholders.

Within this project, CE Delft provided the CO₂ factors per tonne of waste, for use in the overall CO₂ assessment.

Website: www.cedelft.eu

Contact: Marijn Bijleveld, MSc (bijleveld@ce.nl)

Content

01	Executive Summary	6	5.6	Aluminium	78
02	Introduction	8	5.7	Wood	81
03	Methodology and Data Basis	16	5.8	Textiles	84
3.1	Projections: Three Scenarios	17	5.9	Biowaste	87
3.2	Data Modelling – Waste volume	26	5.10	Waste Tyres	90
3.3	Data Modelling – CO ₂ factors	32	06	Main Results for Residual Waste/WDF	93
04	Overview of Main Results	46	07	Key Observations	98
05	Main Results per Waste Stream	60	A	Annex	102
5.1	Material Waste Stream Total	61	A1	Allocation of EWC-Codes to Waste Streams	103
5.2	Paper & Cardboard	64	A2	CO ₂ Factors: Sources and Explanations	116
5.3	Glass	67	A3	CO ₂ Factors per Scenario	134
5.4	Plastics	70	A4	Bibliography	145
5.5	Ferrous Metal	75			

Glossary of Terms

a	anno	LCA	Life Cycle Assessment
BAT	Best Available Technique	LHV	Lower heating value
CDW	Construction and Demolishment Waste	LDPE	Low-density polyethylene
CH	Switzerland	LoW	List of Waste
CHP	Combined Heat and Power	Max.	Maximum
C&I	Commercial and industrial waste	MBT	Mechanical-biological treatment
CO₂	Carbon Dioxide	MSW	Municipal Solid Waste
CO_{2eq}	CO ₂ equivalents	Mt	Million tonnes
D 10	Disposal operation - Incineration on land	PET	Polyethylene terephthalate
ELT	End-of-Life Tyres	PP	Polypropylene
ELV	End-of-Life Vehicles	PS	Polystyrene
EPDM	Ethylene propylene diene monomer	PVC	Polyvinyl Chloride
EPR	Extended producer responsibility	R 1	Recovery operation - use principally as a fuel or other means to generate energy
ETRMA	European Tyre & Rubber Manufacturers Association	RoW	Rest of world
EU	European Union	SEBS	Styrene ethene butene styrene copolymer
EWC	European Waste Catalogue	t	Tonnes (metric, equal to 1,000 kg)
EWC-Stat	European Waste Classification for Statistics	Thsd.	Thousand
GHG	Greenhouse gases	TOC	Total organic content
GJ	Gigajoule	TRL	Technology Readiness Level
GWP	Global Warming Potential	UK	United Kingdom
HDPE	High Density Polyethylen	WDF	Waste derived fuel
IPCC	Intergovernmental Panel on Climate Change	WEEE	Waste of Electrical and Electronic Equipment
kg/ihn	Kilogram per inhabitant	WtE	Waste to energy

Executive Summary

01

Executive Summary

Objectives and methodology

- This study, building on the previous study (2008), sheds light on the waste management industry's treatment volumes and associated CO₂ emissions of selected waste streams. Respectively, this study seeks to stimulate the discussions on the realisation of the potentials outlined in this study.
- The waste management industry has many cross-industrial linkages. For example, recovered materials are used by the manufacturing industries or for energy generation. In the process primary raw materials and fossil fuels are substituted. Associated CO₂ burdens and avoidances are not included in a solely sectoral perspective, as avoided emissions are attributed to other industries. The waste management industry fulfils, however, an important role in making wastes available as secondary resources for material and energy use. This study highlights the important contributions of the waste management industry to key European Union policy objectives by accounting the net emissions for 10 selected waste streams.
- Potential CO₂ emission reductions are examined against the background of recent revisions of the EU waste legislation. The study explores the potential contribution this legislation and the waste management industry could have to reaching the aim/ambition of climate neutrality by 2050 set out in the European Green Deal, as well as the effect of more ambitious targets.
- Towards this aim, three scenarios are modelled: Baseline "Current status Quo" (2018) and two projections: "Implementation of current legislation" (Projection 1) and the highly ambitious "Potentials" (Projection 2).
- The volume of the selected material waste streams and residual wastes/WDF (waste derived fuels) are calculated by waste treatment route, such as material or energy recovery, by modelling country specific waste volumes, and harmonized waste streams' and treatment specific CO₂ factors. While the waste volumes are kept constant at the 2018 level, different treatment routes are modelled to reflect the designated targets in the projections and the resulting changes in CO₂ emissions. Not taken into account are other factors (e.g. change in waste composition, demographic change, market demand and prices, etc.).

Key results

- In the 20-year time horizon GWP (Global Warming Potential*), the waste industry is for the selected waste streams almost CO₂ net neutral (13 Mt CO_{2eq}). Considering only the selected 9 material waste streams, the waste industry is already contributing to a net avoidance of 96 Mt CO_{2eq} i.e. more than it is producing. In so doing the waste management industry is already making key contributions to limit climate warming; one of the European Union's policy priorities.
- By successfully applying current waste legislation (Projection 1) by 2035 across the EU27+UK, the CO₂ emission avoidance is significantly improved to -137 Mt CO_{2eq}, delivering a potential saving of ~150 Mt CO_{2eq}. The current baseline CO₂ net emission burden of 13 Mt CO_{2eq} in the 20-year perspective could drop to -283 Mt net emission avoidance in the more ambitious projection 2, delivering an additional potential saving of ~146 Mt CO_{2eq}.
- The current largest net emission savings (negative) are achieved by the recycling of the ferrous metal and aluminium waste streams by avoiding significant emissions by the substitution of primary material production. Combined their net emissions already make up -180 Mt CO_{2eq}, with the potential to fall to -200 Mt CO_{2eq} under the current legislation projection for 2035.
- The largest gains are made by reducing landfilling of particularly organic waste materials, such as paper & cardboard and biowastes, achieving a reduction by up to 120 Mt CO_{2eq}. Additional significant potential reductions are provided by the treatment routes of residual wastes/WDF. In the results for the combined totals of material waste streams and residual wastes/WDF it is not possible to directly identify the landfill and recycling targets. Minimum recycling targets of 65% (after sorting) and maximum landfill target of 10% are met. Since residual wastes include sorting and recycling residues, in the overall results recycling percentages (output rate) appear lower and landfill percentages appear higher.
- To achieve maximum CO₂ avoidance policy makers are, therefore, advised to make optimal use of all available capacity for recycling and waste-to-energy within EU27+UK.

* The Global Warming Potential is the heat absorbed by any greenhouse gas in the atmosphere equivalent to the mass of carbon dioxide (CO₂). For other gases other than CO₂ the potential depends on the gas and the time frame and expressed as CO₂ equivalent (CO_{2eq}). A 20-year time horizon was selected, given the recent IPCC report's emphasis on the need to reduce GHG-emissions fast. In addition, sensitivities for a 100-year and a 20-year marginal approach are provided for comparison.

Introduction

02

Resource savings and potential in waste management and the possible contribution to the CO₂ reduction target in 2020

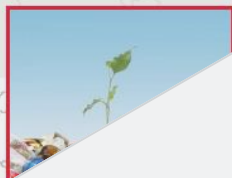

Study 2008

© Prognos AG



First study 2008

...on resource saving and CO₂ reduction potentials in waste management in Europe and the possible contribution to the EU CO₂ reduction target in 2020

- carried out by a team at Prognos AG in co-operation with the Institute for Environmental Research at the University of Dortmund and IFEU - Institut für Energie- und Umweltforschung Heidelberg GmbH
- supported by a unique coalition of European waste management associations
- **Scope:** municipal residual waste plus 18 additional waste streams



Main result

- Identification of CO_{2eq} reduction potential from material recycling of municipal residual waste and additional streams
- Compared to the reference year 2004, the waste management in Europe can contribute to significant additional CO₂ emission reductions by recycling by between 146 - 244 Mt CO_{2eq} and, thereby, contribute between 19% - 31% to the European climate reduction targets of 780 Mt CO_{2eq} until 2020.

Achievements in CO₂ reduction since 2004 for selected waste streams

Divert from landfills

- The 2008 published study conveyed a clear message “Divert from landfill”: a key for a new and intelligent waste management system, which can act as an integrated part of a sustainable environmental, economic, and energy policy.
- The 2008 study highlighted that the resolute abandonment of landfilling for biodegradable waste and waste with high calorific value is one of the key drivers to reaching sustainable waste management in Europe by 2020.
- **Material waste streams**
 - Considering the same material waste streams as in the current study, in 2004 **178 Mt** of the material waste streams were still being landfilled i.e., 44%.
 - In scenario 1 it was assumed that by implementing the 2008 applicable legislation a reduction to 27 % in 2020 could be achieved.
 - The results for **2018** show a landfill reduction to **18 %** on average for the material waste streams. However, it must be noted, that for textiles and biowaste and to a certain extent for plastics no significant reductions have been achieved.
- **Municipal solid waste**
 - The 2008 study revealed that in 2004 **47%** of the municipal waste was landfilled (**119 Mt**).
 - By 2018 this amount was reduced to 24% on EU average (**56 Mt**), with significant differences between the Member States.

Waste as Resource (1 of 2)

- The 2008 study found that above all the **recycling** of paper, metal, clean plastics, glass, and textiles provides clear and documented climate protection benefits. Thus, recycling of these materials should be clearly supported for a better raw material use of wastes in all European Member States.
- **Material waste streams**
 - In **2004** the input-based recycling rate for the considered material waste streams would have amounted to **49%** by 2020 on average across the EU Member States.
 - In scenario 1, the amount of waste generated was kept constant at 2004 level and the full implementation of the in 2008 applicable legislation was assumed. Based on the scenario assumptions a recycling rate of 63% (input-based) would be achieved by 2020.
 - In **2018** an average EU recycling of **56 %** (input-based) was achieved. The gap is caused mainly by the still low recycling rates of biowaste and textiles.
- **Municipal solid waste**
 - The amount of municipal solid waste prepared for recycling/composting (input-based) amounted in **2004** to **90 Mt** i.e., 36 % of the amount generated.
 - In **2018** already a share of 48 % (**120 Mt**) was achieved. Based on the methodology of the 2008 study this leads to CO₂ emission savings of **182 Mt CO_{2eq}**, with significant differences among the Member States. The assumed results of the 2008 study for scenario 1 (158 Mt/2020) have not yet been fully fulfilled.
 - The resolute abandonment of landfilling for biodegradable waste and waste with calorific value suitable for energy recovery will remain one of the key drivers in reaching a sustainable waste management in Europe.

Source: Prognos 2008

Achievements in CO₂ reduction since 2004 for selected waste streams

Waste as Resource (2 of 2)

- Considering waste as a resource includes also thermal recovery of all waste fractions and residual waste/WDF not suitable for recycling. In this regard the 2008 study called for a more energy efficient use of the respective waste materials.
- **Municipal solid waste**
 - In **2004**, nearly 44 Mt of municipal waste was incinerated with or without energy recovery, leading to CO₂ emission savings of about 3 Mt CO_{2eq}.
 - For scenario 1 the direct amount of municipal waste thermally treated was assumed to increase until 2020 to 52 Mt. Additional 26 Mt were assumed to be treated through mechanical-biological methods for fuel preparation and stabilization.
 - Current data for 2018 show a relevant contribution of waste to energy. In total 72 Mt of municipal waste were thermally treated, and energy recovered.
- **Residual wastes/WDF for thermal treatment**
 - Regarding the residual wastes and WDF, both studies' methodologies differ and are not directly comparable. In the 2008 study only a share of higher quality WDF was considered.

Source: Prognos 2008



Study 2021

© iStock-Animaflora



Objective

- Analyse the CO₂ net-savings already achieved by the waste management industry within the EU 27+UK for a selection of material waste streams, which have a high material recycling potential, incl. their residues, mostly originating from pre-treatment and recycling activities, and other residues.
- Identify and present the still untapped potential for avoiding CO₂ emissions.
- Potential CO₂ emission reductions are examined against the background of recent revisions of EU waste legislation, circular design, and use of products set out in the new circular economy action plan, as well as a highly ambitious development in waste management practices across Europe.

Objectives and scope (1)

Identifying the potentials to protect the climate and save resources

- The **urgency to act on climate change** has grown significantly in the last decade. Simultaneously, efforts for a circular and green economy have picked up pace to not only reduce CO₂ emissions, but also to reduce primary resource usage and increase material circularity.
- The present study, supported by a coalition of European waste management associations, identifies the potential CO₂ emission reductions that can be achieved by the waste management industry in the coming decade for a selection of waste streams. Potential CO₂ emission reductions are examined against the background of recent revisions of EU waste legislation, circular design, and use of products set out in the new circular economy action plan, as well as a highly ambitious development in waste management practices across Europe. In so doing, the study explores the potential contribution the waste management industry could have to reaching the aim/ambition of climate neutrality by 2050 set out in the European Green Deal.
- The **general objectives of this study** are:
 - To analyse and present the CO₂ net-savings already achieved by the waste management industry within the EU 27+UK via a selection of material waste streams, which have a high material recycling potential, incl. their residues, mostly originating from pre-treatment and recycling activities, and other residual wastes/WDF.
 - To identify and present the still untapped potential of avoiding CO₂ emissions within the EU 27+UK by implementing the recent EU waste regulation to determine the possible contribution of the waste management sector to reducing CO₂ and to reaching the reduction targets set by the EU.
 - To provide an overview of the identified resource saving potential when waste is recycled or used as fuel for energy recovery/other thermal treatment.
 - To identify the potentials arising from the EU landfill targets and more ambitious theoretical future reductions.
- The following **selected waste streams** are assessed:
 - Paper
 - Glass
 - Plastics
 - Ferrous metals
 - Aluminium
 - Wood
 - Textiles
 - Waste tyres
 - Biowaste
 - Residual waste/WDF: mixed municipal waste (non-recycled) and rejects from waste treatment/waste derived fuels
- This study, therefore, does not include all waste streams.
- The **main waste sources**, from which these selected waste streams are comprised, include commercial and industrial waste, construction and demolition waste, municipal waste amongst others. Information on their statistical composition can be found in the Annex – EWC codes. Not considered was home composting. This treatment option was not considered due to a lack of data. In addition, while the circular economy action plan sets out ambitions for the overall waste reduction, this study holds waste volume constant at 2018 levels to portray the effect of changed targets on volumes by treatment route and CO₂ emissions.
- A **20-years time horizon** was selected given that the recent IPCC report highlighted that sectors that emit large amounts of methane (e.g. agriculture and waste management) and black carbon (e.g. residential biofuel) are important contributors to warming over short time horizons of up to 20 years. The 20-year time horizon better represents the so-called ‘individualistic’ point of view of humans, i.e. emissions affect the lives of the currently living people (most), can be technologically solved and adapted to. It provides a perspective stressing greater urgency. Consequently, it was chosen as the default for this study.

Objectives and scope (2)

Identifying the potentials to protect the climate and save resources

- The **intention of the study** is to help the EU decision-makers in their aim to reduce CO₂ levels. It also seeks to contribute to establishing a sustainable European society in which waste is (re)used in an effective and efficient way. Lastly, it attempts to help increase Energy Recovery/other thermal treatment to reduce the dependence on fossil fuels, and facilitate the discussions on how the identified potentials can be realised in practice.
- Towards this aim, the following key parameters are modelled in a Baseline "Current status Quo" (2018) and two projections: "Implementation of current legislation" (Projection 1) and the highly ambitious "Potentials" (Projection 2).
- **Waste volume:** The volume of the selected material waste streams and residual wastes/WDF were calculated by waste treatment route, such as material or Energy Recovery/other thermal treatment, as secondary raw materials or fuels. While the waste volumes were kept constant at the 2018 level, different treatment routes were modelled to reflect the designated targets in the projections. These affect the energy and resource use of the respective EU Member States plus the UK. Details can be found in the Chapter 3 Methodology and Data Basis and Annex – EWC-Codes.
- The main **treatment paths** of the material waste streams are shown in this study.
- **CO₂ emission factors:** CO₂ equivalence factors were derived based upon the most recently available data to show the net CO₂ emissions from waste processing and associated emission avoidance. Details can be found in the Chapter 3 Methodology and Data Basis and Annex – CO₂ factors.
- Given the limited data basis for mainly transboundary movements and very limited carbon impact of transport compared to the treatment method, the figures do not include transport emissions. A sensitivity incl. transport emissions is simulated for the residual wastes/WDF (as defined by this study) in Chapter 6.
- **Net CO₂ emissions by waste stream** were calculated for the current net CO₂ emissions according to the waste processing route of the selected waste streams to provide a baseline for comparison with the 2 projections. A 20-year time horizon was used applying a net CO_{2eq} calculation method based on IPCC [2013]. The CO₂ calculation is based on the country specific waste generation data. To indicate sensitivities alternative CO₂ calculation approaches (GWP) were also computed, i.e. a 100-year time horizon and a marginal approach. Details can be found in the Chapter 3 Methodology and Data Basis and Annex – CO₂ factors.
- **A 20-year time horizon** was selected, given the recent IPCC report's emphasis on the need to reduce GHG-emissions fast. From a LCA-methodology perspective, the 20-year time horizon better represents the so-called 'individualistic' point of view of humans and a sense of urgency i.e. emissions affect the lives of the currently living people (most) and can be technologically solved and adapted to.
- The CO₂ factors are **harmonized** to ensure comparability between countries. This means that average EU CO₂ factors for different waste processing activities per waste stream were derived and applied to all Member States.
- **Regional focus:** The report considers the EU 27 Member States plus the UK. The selected waste streams were derived based on official statistical sources (e.g. Eurostat) **at country level**, where available. The modelling of the Baseline and projections were confronted with several challenges, especially concerning limited data availability. This necessitated the use of several modelling assumptions, which are detailed in the subsequent Chapter 3 Methodology and Data Basis.
- For comparability, the waste volume was held constant at the 2018 Baseline-level for the Projections 1 and 2. Potential impacts of selected key drivers influencing the quantity, such as population growth, thus, are not considered.

Carbon Emissions from Waste Management

Waste management activities according to the sectors of the National Greenhouse Gas Inventories

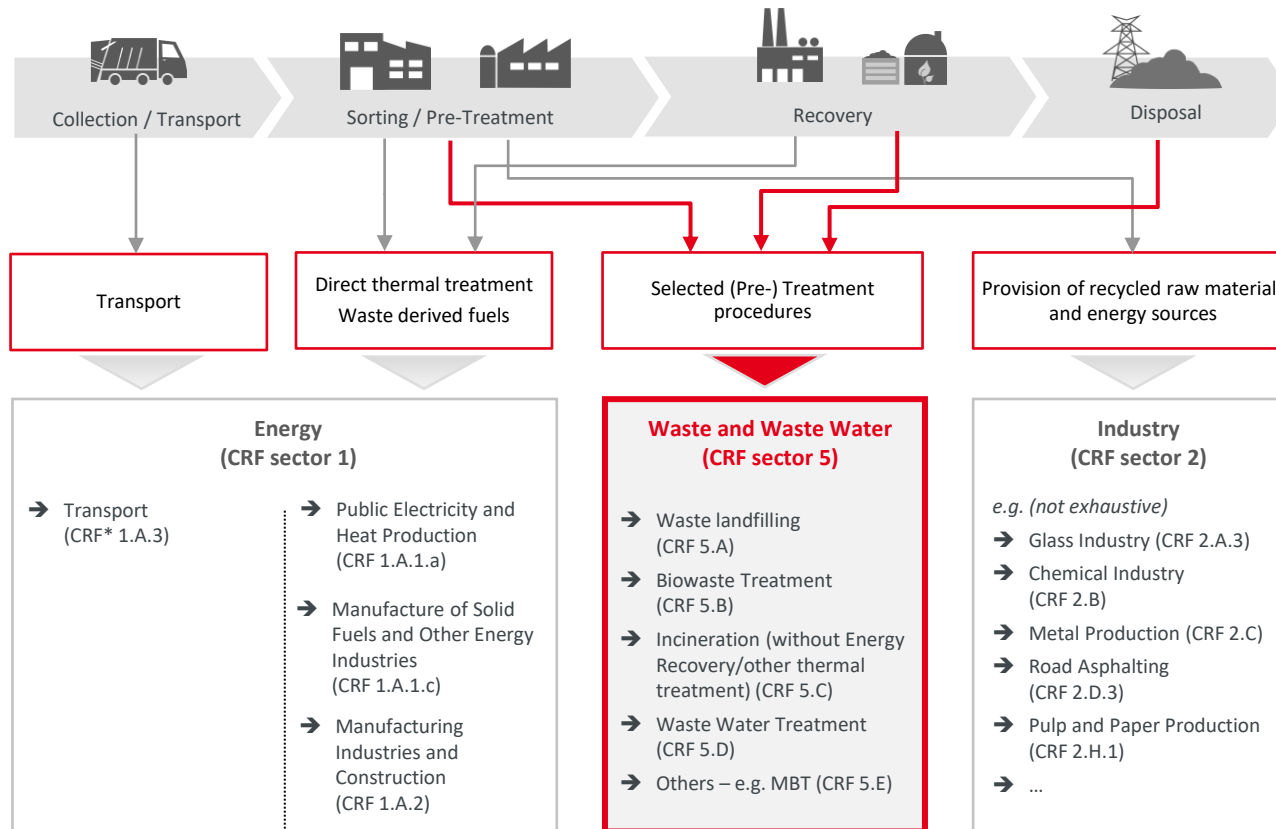

- Waste management cannot be regarded as a silo industry, as many interlinkages to other sectors exist. Some of these activities are causing, others preventing GHG-emissions such as:

- Emissions from transport (waste collection, transport of residuals, secondary raw materials (more recently/future: avoided emissions from fuels co-produced for incineration).
- Avoided-emissions through the provision of heat and electricity replacing fossil fuels.
- Avoided-emissions in industries using waste derived fuels such as cement and metal industry replacing fossil fuels.
- Avoided-emissions in industries processing recycled raw materials replacing the extraction and processing of primary raw materials.

- The present structure of the national greenhouse gas inventory reported to the UNFCCC, which the IPCC bases its calculations on, however, only incompletely describes these interlinkages, as emissions are calculated by sector. Thus, it incompletely describes the services of waste management in climate protection via sector 5 "waste".

- To model the climate impact of waste legislation these interlinkages need to be considered.

*CRF: Common reporting format (CRF) tables – a series of standardized data tables containing mainly quantitative information
Source: [IPCC 2019]

Methodology and Data Basis

03



Projections – Three scenarios



Assumptions for Projections

© iStock - diephosi

Three scenarios

SQ

Baseline - 2018

“Status quo”

CO₂-emissions* from current waste processing in the EU27 and the UK in 2018.

P1

Projection 1 - 2035 (2040)

“Implementation of current legislation“

CO₂-emissions* from waste processing in the EU given a successful implementation of existing waste regulation and recycling targets by EU27 and the UK, which are extended to commercial and industrial waste (see full assumption in slide 22).

P2

Projection 2 - 2035

“Potentials”

CO₂-emissions* from waste processing in the EU27 and UK incl. the impact of a more ambitious CO₂-emissions legislation with more recycling and less landfilling.

* Net CO_{2eq} emissions are calculated based on a 20-year global warming potential (GWP) perspective.

Baseline - 2018

„Status quo”

Background

- **Goal:** The goal of this study is to show the net CO₂ emissions from waste processing in the EU27+UK by providing a baseline for comparison with the two future projections.
- **Waste volume:** The volume of the selected material waste streams and residual wastes/WDF were calculated by waste treatment route, such as material or Energy Recovery/other thermal treatment, as secondary raw materials or fuels. While the waste volume was kept constant, different treatment routes were modelled to reflect the designated targets in the projections. These effect the energy and resource use of the respective EU Member States plus the UK. Details can be found in the Chapter 3 Methodology and Data Basis and Annex – EWC-Codes.
- The main **treatment paths** of the material waste streams are shown in this study.
- **CO₂ emission factors:** CO₂ equivalence factors were derived based upon the most recently available data.
- **Net CO₂ emissions by waste stream:** CO₂ equivalence factors were calculated based upon the most recently available data using a 20-year time horizon by applying a net CO_{2eq} calculation method based on IPCC [2013]. The CO₂ calculation is based on the country specific waste generation data. To indicate sensitivities, alternative CO₂ calculations approaches were also computed, i.e. a 100-year time horizon and a marginal approach.

Assumptions

- **Waste data:** Given that no complete dataset on the individual treatment and disposal routes for the selected waste streams exists, estimations of waste volumes generated were derived based upon statistically recorded wastes within the EU 27+UK in 2018. For this end, a broad range of waste related official documents, studies and waste stream related literature were analysed. Additionally, several interviews with relevant stakeholders were carried out to verify necessary assumptions regarding waste composition, waste stream specific shares, treatment routes, as well as sorting and recycling losses. Compared to the 2008 study, the availability of official detailed waste data has declined.
- **Included waste streams:** The inclusion of waste sources of the selected waste streams, as described in the Introduction and more detailed in Annex – EWC-Codes, was as extensive as possible.
- **Data gaps and inconsistencies:** In addition to the lack in the detail of the available and current waste data, data inconsistencies were identified, e.g. between the waste volumes originated and treated across Europe. Reasons may include import-export effects, exclusion of certain recovery and disposal (R/D) treatment procedures, data confidentiality, direct deliveries to production facilities, or methodological and data errors.
- Due to limited **data availability**, CO₂ emission factors are derived for the overarching situation across EU27+UK by waste stream and treatment route (see Annex - CO₂ Factors Sources and Explanations). CO₂ factors may differ in certain Member States from the harmonized factors used in this study, e.g. due to differences in electricity mix, WtE plant efficiencies, landfill practices and energy efficiency at recycling facilities.
- To provide a holistic picture, **net CO₂ emissions are shown**, which is the sum of the emissions generated by the waste treatment route and the avoidance through, e.g., the waste's material or Energy Recovery/other thermal treatment. Their composition is detailed in the Annex - CO₂ Factors per Scenario.

Projection 1 - 2035 (2040)

„Implementation of current legislation“

Background

- **Goal:** The goal is to show the impact of the implementation of the **existing European legislation** with a focus on the selected waste streams of the study, i.e., to show the development against the Baseline.
- **Considered legislation:** Existing EU Directives to be implemented into national legislation formed the basis of the targets. Already achieved higher targets are carried over. Additional specific national legislations were not considered. The achievement of the targets per Member State was assumed. A derogation option for respective countries was considered by a marginally lower target and modelled as a sensitivity. For the realization of the legislation targets, it was assumed that societal behaviour, product design, and technical capacities are given.
- **Net CO₂ emissions by waste stream:** CO₂net-emissions by waste streams were calculated for Projection 1 to identify the future potential CO₂ savings compared against the status quo Baseline.
- **Theoretical potential:** The modelled projection reflects the theoretical potential assuming the use of best available technologies, along with necessary behaviour, societal and product design changes.

Assumptions

- **Waste volume:** For the projections 2035 the waste volume was held constant at the 2018 level. Potential impacts of selected key drivers influencing the quantity, such as population growth or changes in waste composition, were not considered.
- **Calculation method:** Given the data situation and for reasons of comparability, calculation method 4 (calculation of preparation for re-use/recycling against the total municipal waste) was applied to all countries considered regardless which method was applied domestically. It follows the method pursuant to Decision 2011/753/EU “Preparation for reuse and recycling of municipal waste”. This calculation method is related to the recycled amount of municipal waste in general.
 - This implies a change of calculation methodology to an output-oriented methodology (i.e. point of measurement) requiring the application of average sorting losses to derive the needed recycling output to achieve the modelled recycling target.
- For comparability, the applied CO₂ factors have the same methodological background as the factors for the Baseline scenario.
- The current legislation scenario refers in this study to the waste treatment route targets. The requirements of the EU Landfill Directive to extract landfill gas for energy use is not considered. This allows for better comparability against the baseline. Also only limited data is available for its calculation. The model considered an average methane recovery rate of 53% as provided by the available datasets. The datasets, therefore, include the net methane emission.
- **Modelled targets and sorting and recycling losses:** Based upon the considered legislation, targets for recycling and landfilling were modelled. In addition, it was assumed that the sorting losses of specific wastes are lower through improved sorting and pre-treatment technology and behavioural change. In contrast, recycling losses from heterogenous wastes were increased, where possible, to account for the increasing challenge to extract recyclable material. For details and additional assumptions on treatment routes see Chapter 3.2 Data Modelling.

Projection 2 - 2035 (2040)

„Potentials“

Background

- **Goal:** The goal is to show the impact of a **more ambitious legislation with more recycling and less landfilling** of the selected waste streams of the study resulting in an increase in energy recovery/other thermal treatment, i.e., to show the development against the Baseline.
- **Net CO₂ emissions by waste stream:** Net CO₂net-emissions by waste stream were calculated for Projection 2 to identify the future potential CO₂ savings of more ambitious targets compared against the status quo Baseline, given that realistic technical optimization, societal behaviour, product design and technical capacities are provided to protect the climate.
- **Theoretical potential:** The modelled projects reflect the theoretical potential assuming the use of best available technologies, along with necessary behaviour, societal and product design changes.
- This scenario is based upon the discussions with the clients on a further marginal intensification of recycling, assuming that technical capabilities and behavioural changes needed by all actors along the value chain are provided.

Assumptions

- **Waste volume:** The projection for 2035 applies the 2018 waste volume as a constant for the projections. Potential impacts of selected key drivers influencing the quantity, such as population growth and change in waste composition, were not considered.
- **Modelled targets and sorting and recycling losses:** More ambitious targets for recycling and landfilling were modelled. Sorting losses were modelled as described for Projection 1. Additional assumptions on treatment routes are described in the Chapter 3.2 Data Modelling.
- **Landfilling:** Waste streams suitable for recycling and recovery were not allocated to landfilling in the modelling of Projection 2, even though it is widely recognized that landfill capacities will need to remain (e.g. to handle contingencies such as flood disasters or other treatment plant breakdowns, as well as to treat wastes not considered in this study). Waste disposal through landfilling here, thus, only reflects the modelled waste streams. If the not considered specific waste streams were included, landfilling may be higher. Also, the requirements of the EU Landfill Directive to extract landfill gas for energy use is not considered (also see Projection 1).
- **Technological developments:** The waste management industry is an evolving industry with ongoing technological innovation and development and, thus, improvements in resource conservation and emission reduction. One of these promising developments in the future is chemical recycling and carbon capture, utilisation, and storage. A brief description of these technologies is provided in Chapter 5.4 Plastics and 3.3 Data Modelling – CO₂ factors . As data on the recycling yield, carbon footprint and technical feasibility of chemical recycling and carbon capture are still insufficient, they are not included in the model of this study.
- **Energy mix:** The CO₂ factors for this projection include expected changes to the heat and electricity mix in the year 2035 (see Chapter 3 Data Modelling – CO₂ factors).

Projection 1 and 2

Waste treatment targets

Overview of target-based assumptions for reuse/recycling/recovery

	Projection 1	Projection 2
Recycling	<ul style="list-style-type: none"> • <u>Municipal waste:</u> <ul style="list-style-type: none"> – 65% target (for derogation option 60%) – Output-based calculation based on calculation methodology 4 (pursuant to Decision 2011/753/EU) (measurement point after sorting, see slide 34) – Home composting is not considered • <u>Packaging waste:</u> <ul style="list-style-type: none"> – Implementation of the Material specific Packaging Directive targets • <u>C&I waste (waste streams related):</u> <ul style="list-style-type: none"> – 65% Output-based recycling target as for municipal waste* • <u>CDW (waste streams related):</u> <ul style="list-style-type: none"> – 65% Output-based recycling target as for municipal waste* • <u>WEEE (waste streams related):</u> <ul style="list-style-type: none"> – WEEE category specific targets according to WEEE Directive • <u>ELV (waste streams related):</u> <ul style="list-style-type: none"> – 85% reuse / recycling target • <u>Waste tyres:</u> <ul style="list-style-type: none"> – 95% recovery target / no specific recycling target 	<ul style="list-style-type: none"> • <u>Municipal waste:</u> <ul style="list-style-type: none"> – As Projection 1 – 60% recovery (composting/digestion) target for biowaste • <u>Packaging waste:</u> <ul style="list-style-type: none"> – Higher material specific Packaging Directive targets • <u>C&I waste (waste streams related):</u> <ul style="list-style-type: none"> – 70% Output-based recycling target • <u>CDW (waste streams related):</u> <ul style="list-style-type: none"> – 70% as Projection 1 (recycling target for non-mineral fractions) • <u>WEEE (waste streams related):</u> <ul style="list-style-type: none"> – Higher WEEE category specific targets • <u>ELV (waste streams related):</u> <ul style="list-style-type: none"> – 90% reuse / recycling target • <u>Waste tyres:</u> <ul style="list-style-type: none"> – 80% reuse / recycling target
Landfilling	<ul style="list-style-type: none"> • <u>Municipal waste:</u> <ul style="list-style-type: none"> – ≤ 10% target or status quo if lower (for derogation option 15%), • <u>C&I waste (waste streams related):</u> <ul style="list-style-type: none"> – ≤ 10% target or status quo if lower, as for municipal waste 	<ul style="list-style-type: none"> • <u>Municipal waste:</u> <ul style="list-style-type: none"> – Waste streams suitable for recycling and recovery are not allocated to landfill, ensuring that biowaste is accounted for as diverted from landfills • <u>Packaging waste; C&I waste (waste streams related); C&I waste (waste streams related); CDW (waste streams related); WEEE; Waste tyres:</u> <ul style="list-style-type: none"> – wastes suitable for recycling and recovery are not allocated to landfill. • The landfill treatment modelled only reflects the selected waste streams. Necessary landfilling of other not considered specific waste streams may be higher.
Residues	<ul style="list-style-type: none"> • Average Sorting loss rates per waste stream at point of measurement and recycling loss rates (please refer to next section) • <u>Treatment routes:</u> <ul style="list-style-type: none"> – As per Baseline scenario – Additional losses suitable for recycling and recovery are not allocated to landfill 	<ul style="list-style-type: none"> • Average Sorting loss rates per waste stream at point of measurement and recycling loss rates (please refer to slide 25 for assumptions on sorting/recycling losses) • <u>Treatment routes:</u> <ul style="list-style-type: none"> – Waste streams suitable for recycling and recovery are not allocated to landfill – Note: landfilling of specific residues will still be necessary (e.g. asbestos) but these specific waste streams are not part of the scope of this study.

* Based on the legislative targets for municipal waste, the same assumptions were applied to other waste areas i.e. commercial and industrial waste, and construction and demolition waste, which do not have non-mineral waste stream specific targets, for the selected material waste streams.

Projection 1

European legislation considered

Legal act

Waste Framework Directive 2008/98/EC

Entered into force on 12 December 2008
currently valid version

Directive (EU) 2018/851 of the European Parliament and of the Council of 30 May 2018 amending Directive 2008/98/EC on waste

Entered into force on 4 July 2018

Directive (EU) 2018/850 of the European Parliament and of the Council of 30 May 2018 amending Directive 1999/31/EC on the landfill of waste

Entered into force on 4 July 2018

Relevant regulation

- Legal framework for the handling of waste in the Member States.
- Waste hierarchy for dealing with waste: (1) prevention, (2) preparation for re-use, (3) recycling, (4) other, e.g. Energy Recovery, backfilling (5) disposal.
- Binding targets for the separate collection of recyclable materials from households.
- Recycling targets since 2020:
 - 50% for MSW
 - 70% for mixed CDW

- Binding targets for the separate collection of construction and demolition waste from 2022, organic waste from 2024 and textiles from 2025
- Higher recycling targets for MSW:
 - 2025: 55% → 2030: 60% → 2035: 65%
- Longer transition periods for countries with low recycling and high landfill rates in 2013.
- Change in calculation methodology (output-based)

- Limitation of MSW sent to landfills to a maximum of 10% of the MSW volume by 2035 (2040 for countries that were granted a derogation option as they landfilled more than 60% of their MSW in 2013)
- Limitation of biodegradable waste sent to landfills to a maximum of 35% by weight of biodegradable municipal waste as of 1995 since 2016 (2020 latest for countries that were granted a derogation option)
- Ban on tyres (whole tyres and shredded), medical waste, liquid, flammable, explosive or corrosive waste

Projection 1

European legislation considered

Legal act

Directive (EU) 2018/852 of the European Parliament and of the Council of 30 May 2018 amending Directive 94/62/EC on packaging and packaging waste

Entered into force on 4 July 2018

Directive 2012/19/EU of the European Parliament and of the Council of 4 July 2012 on waste electrical and electronic equipment (WEEE)

Entered into force on 13 August 2012

Directive 2000/53/EC of the European Parliament and of the Council of 18 September 2000 on end-of life vehicles

Entered into force on 21 October 2000

Relevant regulation

- General goal of reducing packaging waste and increasing material recycling.
- Recycling targets until 31 December 2025 → 31 December 2030 respectively (weight as reference value):
 - Plastics (50% → 55%); wood (25% → 30%); ferrous metals (70% → 80%); aluminium (50% → 60%); glass (70% → 75%); paper and cardboard 75% → 85%); packaging in total (65% → 70%).
- Member states shall take measures to increase the share of recyclable packaging, such as deposit systems or economic incentives (Art. 5).
- Member states shall take the necessary measures for the introduction of take-back, collection and recovery systems (Art. 7 (1)).
- Introduction of Extended Producer Responsibility by 31 December 2024 (Art. 7 (2)).

- The main objective of the WEEE Directive is to prevent the production of WEEE and to promote a resource efficient and environmentally friendly handling by re-using, recycling and otherwise recovering of such wastes.
- Targets as per WEEE category from 15 August 2018 for reuse and recycling/recovery:
 - Cat. 1 + 4 (Temperature exchange equipment + large equipment): reuse and recycling rate of 80%, recovery rate of 85%
 - Cat. 2 (Screens and monitors): reuse and recycling rate of 70%, recovery rate of 80%
 - Cat. 5 + 6 (Small equipment + small IT/tele equipment): reuse and recycling rate of 55%, recovery rate of 75%
 - Cat. 3 (lamps): reuse and recycling rate of 80%

- The End-of- Life Vehicles Directive addresses the end of life for cars and automotive products and promotes their reuse, recyclability and recovery
- Targets since 2015 (by average weight per vehicle and year):
 - reuse and recycling: 85%
 - reuse and recovery: 95%

Baseline, Projection 1 and 2

Assumptions on sorting and recycling losses

Overview of assumptions for sorting/recycling losses

Waste stream	Results of literature review / interviews			Sorting losses		Recycling losses	
	No of sources*	Range identified for total losses		Applied in this study		Applied in this study	
		from	to	Baseline (2018)	Projections (2035)	Baseline (2018)	Projections (2035)
Paper	9 (6)	2%	15%	8%	5%	12%	12%
Glass	8 (6)	1%	35%	10%	5%	5%	5%
Plastics	19 (15)	5%	54%	35%	25%	15%	15%
Ferros (Steel)	8 (4)	2%	21%	5%	3%	12%	12%
Aluminium	4 (4)	3%	17%	5%	3%	12%	12%
Wood	3 (3)	4%	10%	10%	5%	10%	10%
Textiles	1 (1)	20%		20%	20%	10%	10%
Biowaste	12 (6)	1%	18%	15%	10%	-	-
Tyres				2%	2%	5%	5%

* Number of data sources identified and evaluated, number in brackets refer to the number of data sources with information for recycling losses

Sources: Desk research, expert interviews

Explanation

- Literature and expert interviews provide varying indications on the sorting losses, i.e. the difference between inputs and outputs of wastes for recycling.
- Figures on sorting losses from available data sources reflect a broad range of specific conditions, such as collection systems (bring-/pick-up systems), collected fractions (single/co-mingled), spatial factors (rural/urban), specific "sub-"fractions (e.g. news paper only) etc.
- In addition, there is not always a clear distinction between losses from sorting and losses from recycling.
- Consequently, a derivation of averages was applied by weighting available data based on the types of collection and countries.
- The respective sorting losses were subsequently applied to the waste specific waste streams in the Baseline and the Projections 1 and 2 as shown in the table to the left.
- Given the heterogenous waste composition of the other considered waste sources, the projections required additional considerations. Given higher impurities of these heterogenous wastes, an up to ~20% higher sorting loss was applied where compatible with the projection targets.
- For the municipal solid waste (MSW) a country specific sorting loss was derived based upon the share of the waste stream in the estimated waste composition of municipal waste.



Data Modelling – Waste volume



Data Basis

© iStock - Tomml-min

Use of comparable publicly available data



Eurostat

For methodological reasons, a comparable and consistent data base for all EU Member States and UK from Eurostat was chosen. The data on the waste generation, treatment, and transboundary shipment published by Eurostat is based on the European Waste Statistics Regulation. The reference year used is 2018.



Other statistical sources

As data published by Eurostat is available on an aggregated level only, additional country specific statistics, as well as statistics provided by relevant associations were assessed to verify the waste stream specific data, fill data gaps, and to derive necessary assumptions.



Literature review / expert opinion

Additionally, a broad range of waste related official documents, studies, and waste stream related documents were analysed and several interviews with relevant stakeholders carried out to verify necessary assumptions regarding waste composition, waste stream specific shares, treatment routes etc.

Data sources used are summarized in Annex Bibliography

Data Modelling

© iStock-AzmanL

Data modelling



Data collection and processing

Waste generation data for the selected waste streams is not available from official statistical sources at the European level. Thus, waste stream volumes needed to be derived by drawing upon the different statistical waste sources across the different waste classification systems and data sources, especially from Eurostat and ETRMA's End-of-Life Tyres statistics.

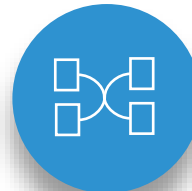

Data modelling – waste volume

Building upon the list of waste (LoW) classification some waste codes are specific, while most have a heterogeneous composition of waste materials. To derive a realistic waste potential, also heterogeneous waste codes were considered. Their composition for each waste stream and country varies. Data inconsistencies and gaps presented a reoccurring challenge at each data processing step.

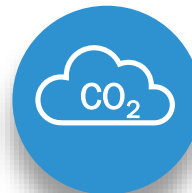

Data modelling – CO₂ factors

The CO₂ emission factors are based on existing inventories, such as the Ecoinvent database, and existing life cycle assessment (LCA) studies. For modelling the treatment routes the Simapro LCA software was used. Existing models have been adapted to represent the EU average situation. The methodology is detailed in the subsequent chapter.

Data Modelling: Data collection and processing

Statistical waste data sources to derive volumes by waste stream

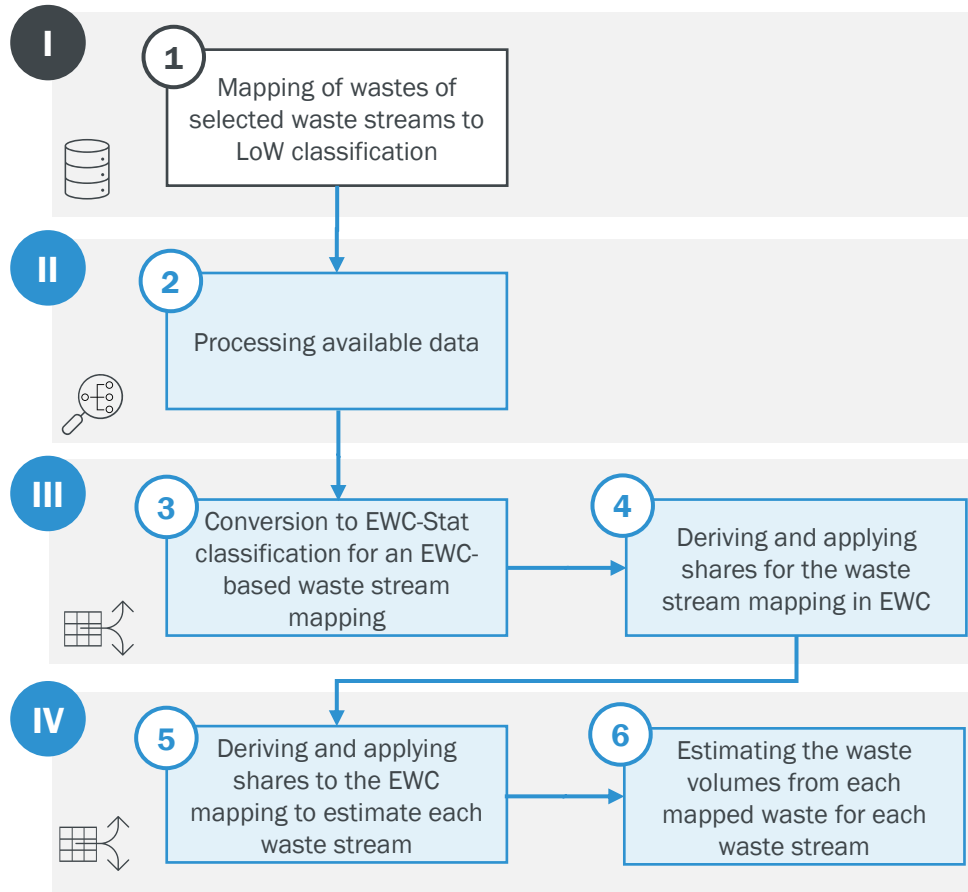

Source: Prognos

Explanation

Waste generation data for the selected waste streams are not available from official statistical sources at the European level. Their waste potential needed to be derived by drawing upon different waste sources across different waste classification systems and data sources.

I. Working step I: Mapping of relevant wastes to selected waste streams

1. Based on the list of waste (LoW) classification relevant wastes were identified and mapped to the selected waste streams (see Annex EWC-Codes).

II. Working step II: Maximising use of available data

2. Available data by LoW classification is, however, insufficient at the European level to derive the data basis on waste stream volume. Detailed waste data in the LoW classification (EWC) is only available for few countries. These are used as input to sub-step 4.

III. Working step III: Conversion of selected LoW to EWC-Stat classification

3. Drawing upon the Table of Equivalence between EWC-Stat Rev 4 and the LoW, the previous LoW mapping was converted to the EWC classification for which waste data is principally available for the EU27+UK.
4. Given no 1:1 relationship, this conversion drew upon the shares of the known relationships between LoW and EWC from the few available countries. Their average was applied to the remaining countries.

IV. Working step IV: Country specific waste stream specific share

5. The shares from sub-step 4 provide an estimate of the relevant wastes to be considered, but not yet the relevant respective part for each waste stream. By drawing upon literature, complementary statistics, and expert interviews, the waste composition of each EWC-mapped waste for each country was decomposed to derive the relevant waste stream part for the respective selected waste stream.
6. The respective shares from step 4 and 5 were applied to the waste data in EWC classification. Sub-step 4 was not applicable to the data sources WEEE and ELT.

Data Modelling: Waste volumes and treatment routes

Baseline: Data modelling (illustrative overview)

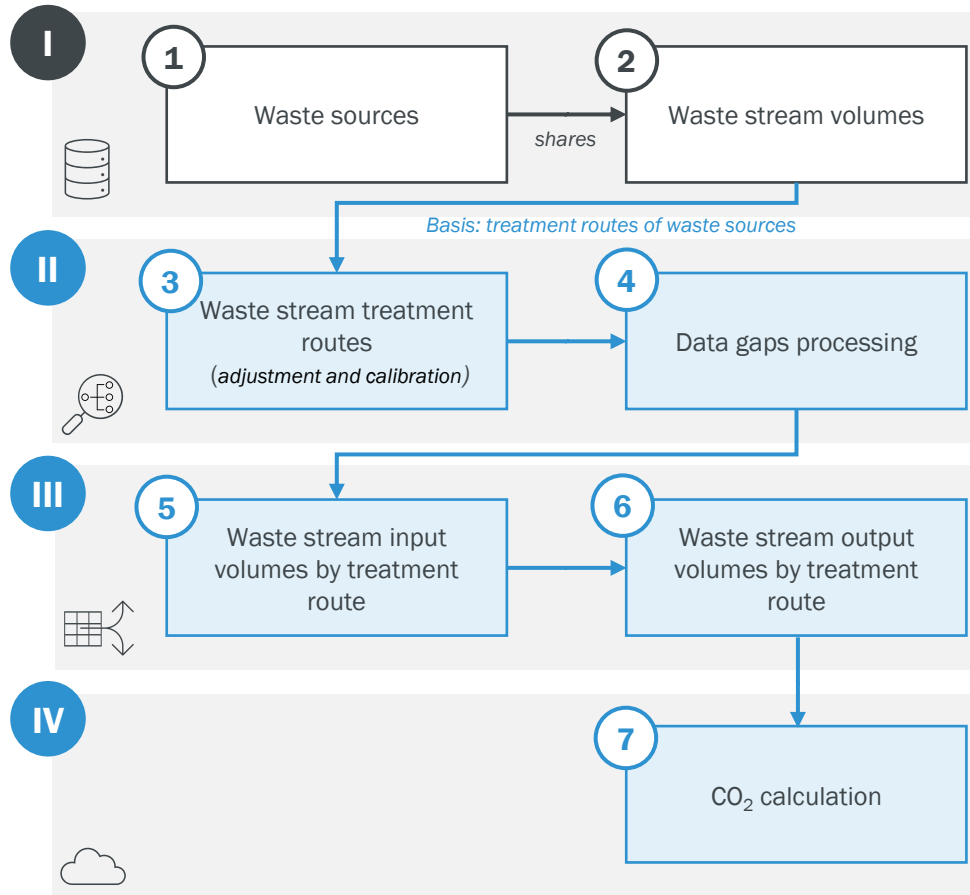

Source: Prognos

Explanation

Data modelling was carried out in 4 working steps with several sub-steps

- I. Working step I: Data collection, processing and deriving of the waste streams** within the scope of this study (described in the previous section)
- II. Working step II: Allocation of treatment routes**
 3. Waste stream treatment routes: The waste treatment routes of the respective EWC-Stat code were applied drawing upon the respective datasets.
 - Data gaps: Projecting data to fill data gaps in treatment routes data and/or by application of the EU average
 4. Generation-Treatment gap in the waste specific wastes: Amount was assumed to be treated mainly within Europe except for plastic and textiles with very large gaps. These gaps are likely caused by exports to outside Europe.
 - As the treatment routes and the quality of final treatment could not be confirmed by the secondary sources, these volumes are processed as an “unknown treatment” and presented separately in the results and considered as additional potentials in the projections. The potential is then assumed as treated in the EU.
- III. Working step III: Treatment routes, sorting and recycling losses**
 5. Adjustments in the recycling treatment volumes
 - Accounting for sorting losses in recycling of the waste specific wastes.
 - Given that most recycled wastes of the selected waste streams are part of the waste specific wastes, it was assumed that the remaining amount in the heterogenous wastes are largely not part of the recycling amount. The respective treatment routes were adjusted to reflect this.
 - These sorting and recycling losses, as well as non-recycled municipal residual waste for the waste streams, subsequently both feature in the material waste streams and residual wastes/WDF. This is marked as a data overlap. The selected material waste streams and residual wastes/WDF are analysed separately.
 - The methodological assumptions on the distribution treatment routes may lead in the case of construction and demolition wastes (esp. for wood), with data available at only a very high aggregate level, which includes soils and stones, to an overestimation of energy recovery/other thermal treatment relative to the other treatment routes.
 6. Additional distributive consideration of the treatment routes for compatibility with the treatment routes provided by the CO₂ calculation method.

Data Modelling: Waste treatment projections

Projections: Data modelling (illustrative overview)

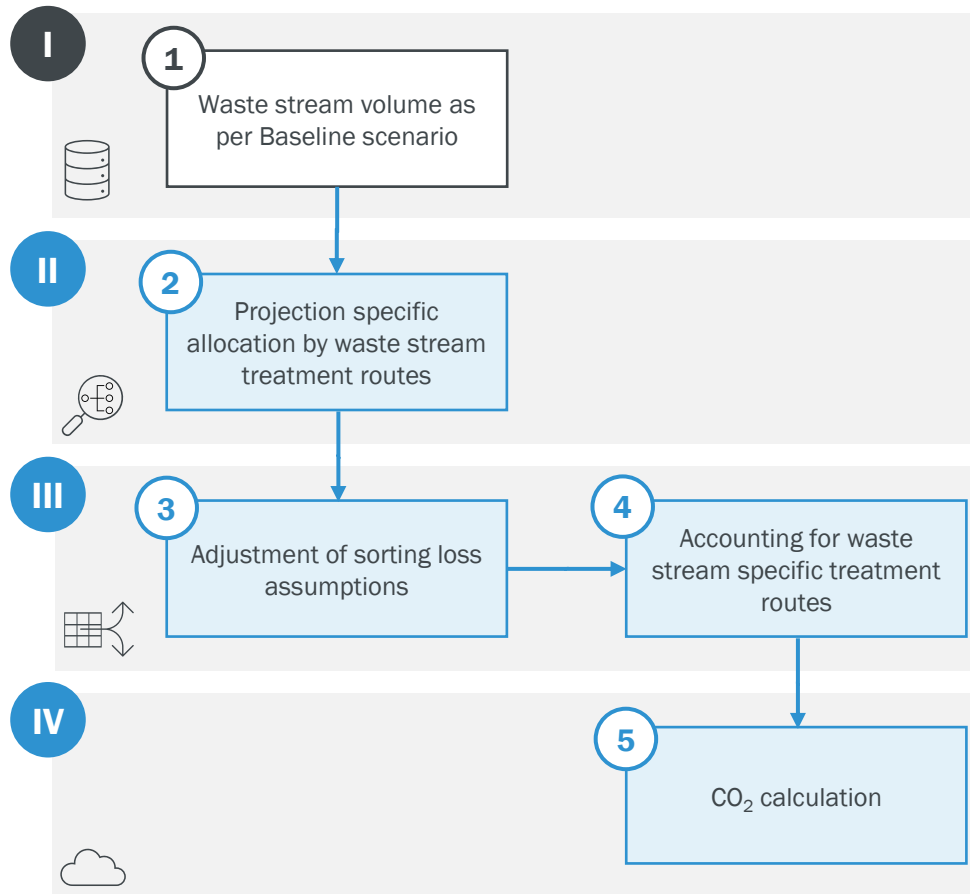

Source: Prognos

Explanation

Projection modelling was carried out in 4 working steps with several sub-steps

I. Working step I: Data transfer from Baseline scenario.

1. For methodological reasons, the amount of waste was left at 2018 levels.

II. Working step II: Target-based allocations

2. Reallocation of waste streams by treatment routes
 - Recycling target: Re-allocating volumes to satisfy an output-based approach and targets defined by Projection 1 and 2.
 - Landfill targets: Re-allocating volumes to satisfy the maximum amount provided by the defined targets.
 - Accounting for derogation option in Projection 1 as the default.

III. Working step III: Treatment routes, sorting and recycling losses

3. Adjustment of assumptions about sorting losses of waste specific wastes as defined for the projections. Considered improvements in collection and sorting/pre-treatment lead to lowered sorting losses and, thus, slightly higher output rates for recycling.
4. Accounting for treatment routes of direct treatment routes and indirect treatment routes (sorting losses)
 - After sorting, and point of recycling target calculation, additional treatment splits for the CO₂ calculation (direct, recycling losses, and sorting loss) are carried out to account, e.g., for difference in residual waste/WDF with a high and low calorific value.
 - These sorting and recycling losses as well as the non-recycled municipal residual wastes subsequently both feature in the material waste streams and residual wastes/WDF. This is marked as an overlap. The selected material waste streams and residual wastes/WDF are correspondingly analysed separately.

IV. Working step IV: Calculation of CO₂ emissions

5. Respective country level treatment volumes computed against available CO₂ factors per waste stream and treatment route for the following GWP/time horizons:
 - 20-year time horizon (with and without derogation option for the MSW targets)
 - 20-year time horizon with marginal approach (as a sensitivity)
 - 100-year time horizon (as a sensitivity)



Data Modelling – CO₂ factors

Data Modelling – CO₂ factors: Methodological background

Methodological background

- A **20-year time horizon** was selected, given the recent IPCC report's emphasis on the need to reduce GHG-emissions fast. From a LCA-methodology perspective, the 20-year time horizon better represents the so-called 'individualistic' point of view of humans and the sense of urgency i.e., emissions affect the lives of the currently living people (most), and that climate change can be technologically solved and adapted to.
- The recent IPCC findings of the recent IPCC report point out that sectors that emit large amounts of methane (e.g. agriculture and waste management) and black carbon (e.g. residential biofuel) are important contributors to warming over short time horizons of up to 20 years. Further, "Cutting methane emissions is the best way to slow climate change over the next 25 years", according to Inger Andersen, Executive Director of United Nations Environment Programme.
- CO₂ factors are **harmonized** to ensure comparability between Member States. This means that the same average EU CO₂ factors per waste stream and treatment were applied to each Member State.
- Per waste treatment route, the net CO₂ equivalent emissions were calculated per tonne of waste. This **net result** represents the emissions minus the avoided emissions, due to generated power, heat, secondary materials or fuel replacing primary material. The net results were linked to the inventoried waste volumes. The emissions, avoided emissions, and net results per tonne of treated waste material are documented in Annex - CO₂ factors.
- The CO₂ factors are based on **existing inventories**, of existing LCA studies and the Ecoinvent database. No new inventory was performed for this study.
- Effects of carbon capture, utilisation and storage of WtE plants were not included in the study's model as it cannot yet be considered a common practice. A brief description is, however, provided.
- Simapro LCA software was used to model the waste treatment routes and calculate the CO₂ factors. The Ecoinvent database v.3.6, available within Simapro, contains environmental (emission) inventories for landfilling, incineration, energy carriers and production of materials.
- Existing models, in which inventory data is linked with environmental background information, have, however, been **adapted** to represent the average current EU situation. For Projection 2 also changes to the model were applied, such as by applying a future electricity mix (i.e., forecast). See details in the Annex.
- The inventory on which the CO₂ factors are based could have originated from a study conducted at national level, or from a specific company. In this study, however, the **background data is averaged on EU level**, for instance, the average EU electricity mix and the EU average net efficiency of waste-to-energy (WtE) plants were applied.
- CO₂ results were calculated with the impact assessment method '**IPCC 20a**' [IPCC 2013]. The time horizon for greenhouse gas (GHG) effects in the atmosphere, thus, is 20-years. CO₂ factors with a 100-year time horizon (IPCC 100a) are also calculated for a sensitivity assessment.
- The avoided emissions from incineration in a WtE plant are based on the average electricity and heat mix. As a sensitivity assessment, CO₂ factors were also calculated with a marginal approach. This means that the most carbon intensive power generation technologies – fossil fuel sources – are avoided instead of the average mix.
- The emission and uptake of **biogenic CO₂** from incineration of biobased materials is excluded and, thus, not part of the CO₂ factors. This is in line with LCA methodology stating that the net emission of biogenic CO₂ is net zero: the uptake of CO₂ from the air by plants and trees is equal to the biogenic CO₂ emission after disposal. The release of (biogenic) methane from landfills is included, since methane is a stronger greenhouse gas than CO₂.

Data Modelling – CO₂ factors: Recycling (1)

System boundaries for recycling

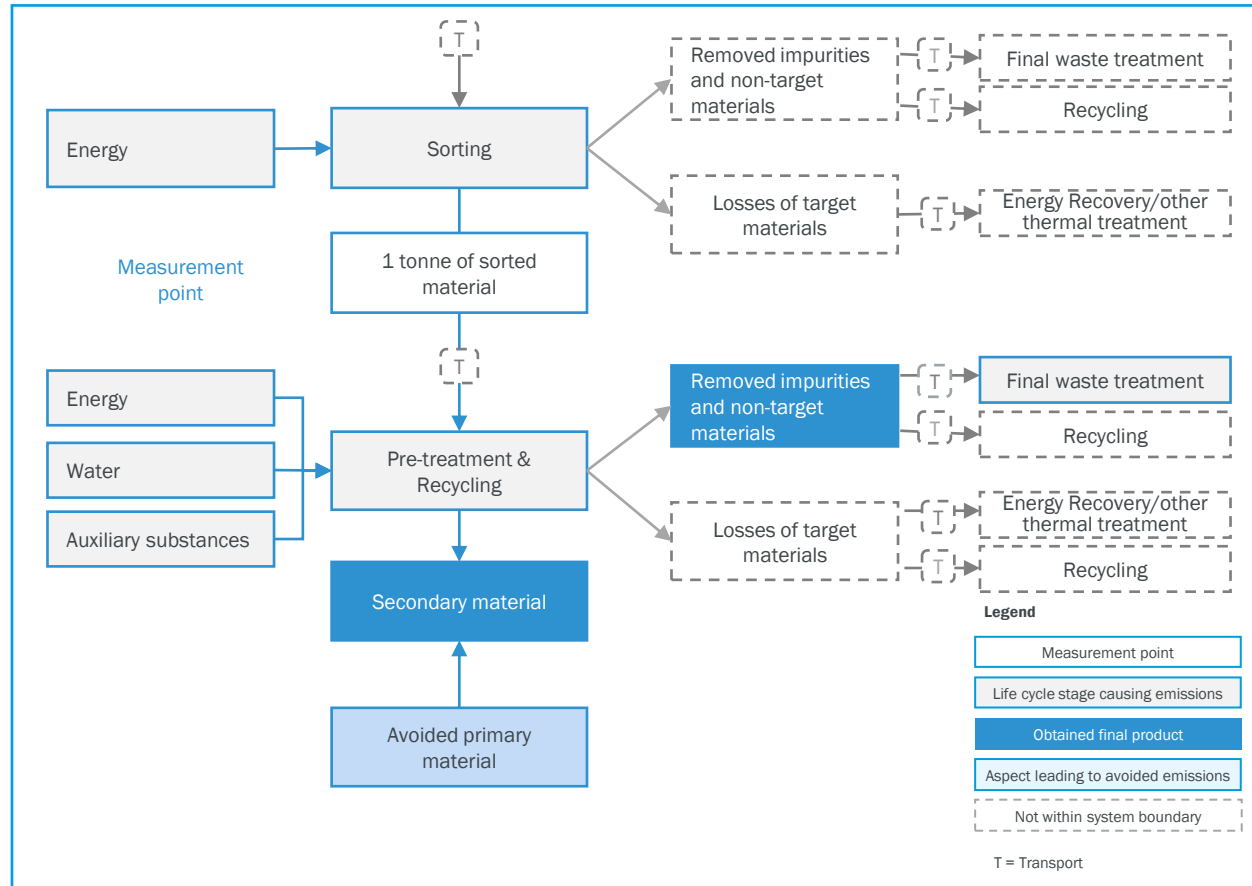

Sources: CE Delft

General explanations

- This figure shows schematically the life cycle stages and products included in the calculation of emissions and avoided emissions by recycling.
- The measurement point for recycling is after sorting. This means that the CO₂ factors are applicable to 1 tonne of sorted material. This approach fits best with the waste volume modelling described above.
- Aspects that lead to emissions are:
 - Energy related to sorting
 - Energy, auxiliary materials, water consumption related to preparation for recycling and recycling processes
 - Final treatment: waste treatment of sludges, residues, removed materials at point of recycling.
- Avoided emission: The mass balance is important. This determines the amount of produced secondary (recycled) material. This secondary material avoids the production of primary materials, leading to avoided emissions.

Data Modelling – CO₂ factors: Recycling (2)

Sorting and pre-treatment

- During sorting and pre-treatment processes, impurities are removed (dirt, non-target materials). Separately collected waste glass, for instance, contains also paper labels, bottle stoppers and lids (cork, plastic, aluminium). As glass is the target material for recycling, during a sorting step these non-target materials are removed. Some are recyclable, such as the metal fraction. Some are suitable for co-incineration (plastics). Remaining residues like sludge are incinerated and landfilled. Each CO₂ factor for recycling of a specific material does not include the recycling or incineration of removed other ('non-target') materials. For the recycling and incineration of each material, a separate CO₂ factor is available. In the CO₂ assessment, in which the CO₂ factors are linked to waste statistics, all recycled and incinerated fractions are included. All fractions are linked to their specific CO₂ factor. For instance, the recycling of metals removed during the sorting processes of glass and plastics recycling are statistically covered under metal recycling, not as glass or plastics recycling. The setup of the CO₂ factors reflects these allocations to avoid double counting.
- During the sorting and recycling process, it is inevitable that some of the target material is lost and will not be recycled. In the example of glass, tiny, sand-like glass fragments are lost while only the larger glass cullets are recycled. The mass balance (input - output) considers these eventual losses of the target material. Finally, the recycled material, also called secondary material, avoids the production of primary materials of similar quality.

Chemical recycling of plastics

Chemical recycling of plastics is only be described qualitatively in the study, rather than quantified, given that:

- Diverse techniques exist for the recycling of various plastic types, which creates a diverse range of final products.
- Techniques are in various stages of development (i.e. technical readiness).
- Full-scale LCAs are mostly confidential.
- Publicly available 'quick scan' figures are based on assumptions and do not cover all process steps and are, therefore, deemed to be too limited to draw robust conclusions from.

Data Modelling – CO₂ factors: Incineration in a waste-to-energy (WtE) plant (1)

System boundaries for incineration in a WtE plant

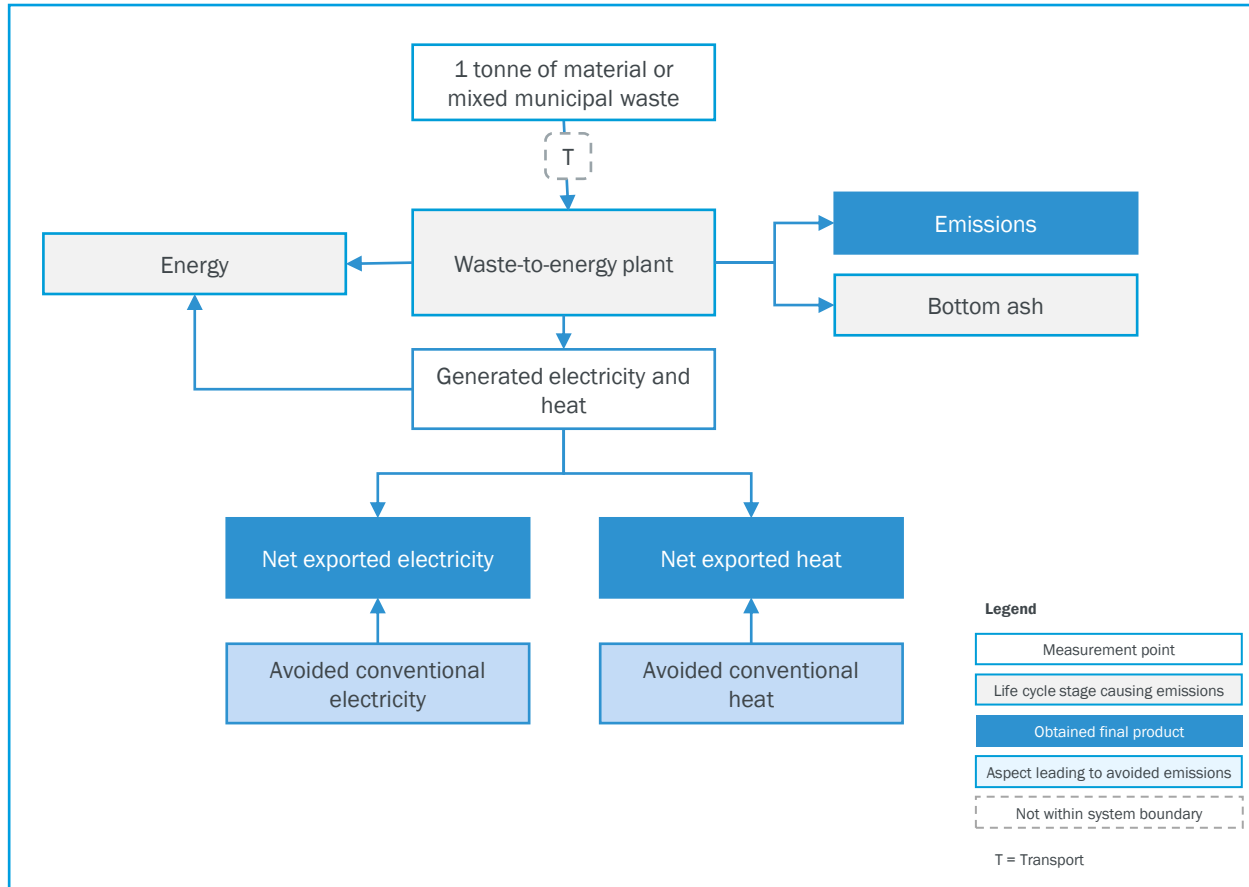

Source: CE Delft

General explanations

- This figure shows schematically the life cycle stages and products included in the calculation of emissions and avoided emissions by incineration in a WtE plant.
- For incineration in a WtE plant the CO₂ factors are applicable to 1 tonne of material. Factors are provided both for specific materials and for average municipal residues.
- Emissions originate from the incineration of the waste itself (direct emission) and energy consumption and auxiliary substance use related to the handling of waste and other operations at the WtE plant.
- A WtE plant generates heat and/or power, which avoids generation of heat and electricity from conventional sources. These avoided emissions are included as a CO₂ benefit (i.e. avoidance) in the study.
- The net result for WtE incineration used in the assessment represents the emissions minus the avoided emissions. The emissions, avoided emissions, and net total per tonne of waste material are reported in the Annex – CO₂ factors.
- Metal recovery from bottom ash is not included in the CO₂ factors for incineration but allocated to the metal waste stream. For steel and aluminium recovery from bottom ash, a separate CO₂ factor is available.

Data Modelling – CO₂ factors: Incineration in a waste-to-energy (WtE) plant (2)

EU average net electrical and thermal efficiencies

- CEWEP [2021] has provided data on net EU efficiencies for electricity and heat from WtE plants for this study:
 - Net export electrical efficiency: 15%
 - Net export thermal efficiency: 32%
- The net efficiencies are based on:
 - A representative sample of WtE plants in the EU in terms of age and type: heat only plants, electricity only plants, and combined heat and power plants.
 - Actual reported electricity and heat, representing the average operating status per plant.
 - Weighting according to capacity.
- The average net efficiencies do not represent a specific WtE plant, but they are representative of the overall EU WtE fleet.
 - There are differences in the operating range of a plant depending on the location and the seasonality. For instance: in Nordic countries WtE facilities are typically more oriented towards heat production, whereas in warmer countries WtE facilities are more oriented towards electricity production.
 - In this study, when calculating CO₂ factors for incineration, the same efficiencies were applied to all materials/waste streams.
- CEWEP also provided an outlook for Projection 2. Higher net efficiencies for both heat and power recovery were predicted, based on the assumption that older plants will be substituted by more efficient facilities, typically as CHP plants that will gradually also become more predominant in Europe in the future.
- The estimated future average net EU efficiencies for electricity and heat from WtE plants, calculated for this study by CEWEP [2021], are:
 - Net export electrical efficiency: 20.4%
 - Net export thermal efficiency: 43.3%

Average EU electricity mix

- The electricity mix is relevant for waste treatment processes, production of primary material (being avoided through recycling) and avoided electricity from other sources by incineration in WtE plants.
- The following CO₂ factors were used within this study for the average electricity mix:
 - Status quo: 0.415 kg CO_{2eq}/kWh (100y perspective)
0.453 kg CO_{2eq}/kWh (20y perspective) [Ecoinvent v.3.6]
 - Projections (2035): 0.150 kg CO_{2eq}/kWh [EC 2020]

Average EU heat mix

- The heat mix is relevant for avoided heat generated from other sources by incineration in WtE plants. The source shows that the heat mix is expected to change only marginally, as the heat sector is facing a greater decarbonization challenge than the electricity sector. Therefore, it is reasonable to assume that the CO₂ factor will be stable for all three scenarios.
- The following CO₂ factor was used within this study for the main assessment: 0.0596 kg CO_{2eq}/MJ [EC 2016].

Source: [EC 2018], [EC 2020], [CEWEP 2021], [Ecoinvent v.3.6], assessment and calculation by CE Delft

Data Modelling – CO₂ factors: Incineration in a waste-to-energy (WtE) plant (3)

EU average net electrical and thermal efficiencies

- Marginal approach: as a sensitivity assessment, results were also calculated with CO₂ factors that represent a marginal approach for avoided electricity and heat from WtE plants. A marginal approach means that the energy generated at WtE plants avoids the most carbon intensive conventional power generation technologies – fossil fuel sources – instead of the average electricity and heat mix that also contains renewable energy.

Marginal EU heat mix

- The share per heat source in Europe is provided by EC [2016].
- The marginal EU heat mix is based on the shares of fossil heat sources extrapolated with the share of renewable heat (27%).
- The future heat mix is expected to change only slightly, as the heat sector is facing a greater decarbonization challenge than the electricity sector. Therefore, the shares were kept the same for all three scenarios.
- The following shares were used within this study:

Fossil power source for heat, marginal approach	Baseline & Projection 1	Projection 2 (2035)
Natural gas	57.5%	57.5%
Coal	2.7%	2.7%
Fuel oil	21.9%	21.9%
Electric	17.8%	17.8%

Marginal EU electricity mix

- The share per electricity sources in Europe is provided by Agora & Sandbag [2020].
- The marginal mix was based on the fossil sources for electricity – oil, coal, lignite and natural gas – extrapolated with the share of non-fossil sources (renewables and nuclear)
- For the future marginal electricity mix it was assumed that the most CO₂ intensive sources – oil, coal and lignite – will be phased out.
- The following shares are used within this study:

Fossil power source for electricity, marginal approach	Baseline & Projection 1	Projection 2 (2035)
Natural gas	54.4%	100%
Oil	9.0%	
Coal	17.0%	
Lignite	19.5%	

- For all power sources, multiple Ecoinvent datasets are available: for most EU Member States datasets are available per power source and sometimes for more than one technique. Per power source, an unweighted average of all the available datasets was created.

Sources: [Agora & Sandbag 2020], [EC,2016], [Ecoinvent v.3.6], assessment and calculation by CE Delft

Data Modelling – CO₂ factors: Co-incineration in coal-fired power plants

System boundaries for co-incineration (coal-fired power plant)

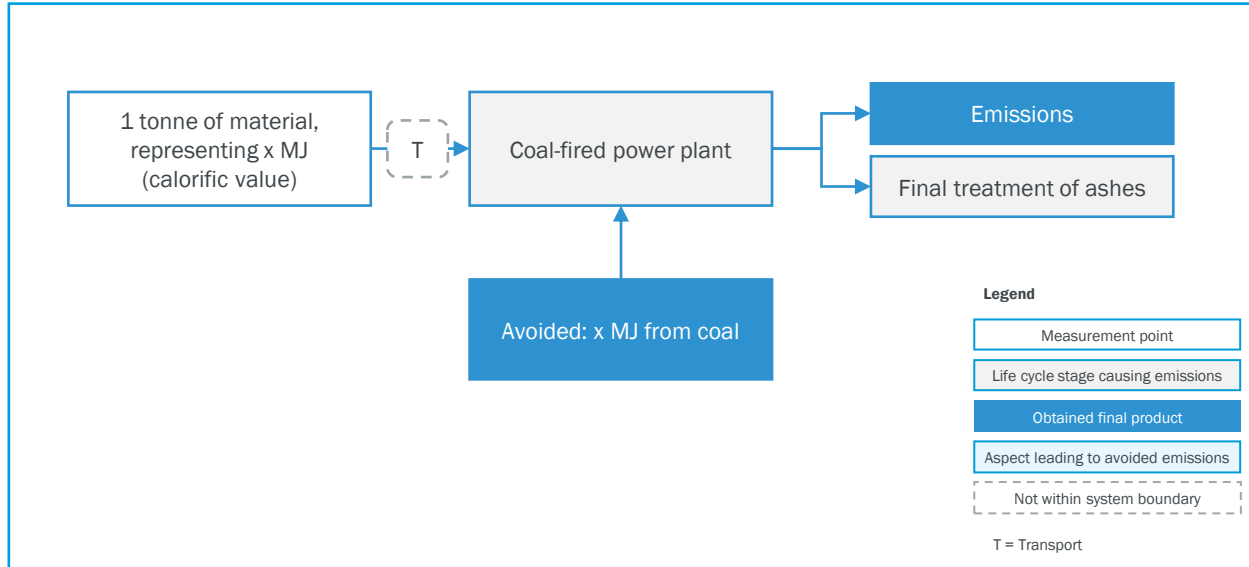

- WDF may be co-incinerated in a coal fired power plant. Not all materials are suited for co-incineration. CO₂ factors are provided for plastics, paper/cardboard, tyres and mixed WDF (paper/plastic).
- A combined CO₂ factor is provided for co-incineration: a certain share of waste is attributed to co-incineration in a coal-fired power plants, another share to co-incineration in cement kilns.

Avoided emissions

- Co-incineration in a coal-fired power plant avoids the use of coal as an energy source. The coal substituted was based on:
 - The lower heating value of the material (for material specific LHVs see Annex - CO₂ Factors: Sources and Explanations)
 - Information on the CO₂ emission per GJ coal incinerated in a furnace: 89,8 kg CO_{2eq}/GJ coal. (Emission factors per energy carrier derived from RVO [2020])
- One CO₂ factor was established for both types of co-incineration. The distribution assumed in this study is:

Co-incineration route	Baseline & Projection 1	Projection 2
Coal fired plants	50%	10%
Cement kilns	50%	90%

Source: [Ecoinvent v.3.6], interviews provided, assessment and calculation by CE Delft

Data Modelling – CO₂ factors: Co-incineration in cement kilns

System boundaries for co-incineration (cement kiln)

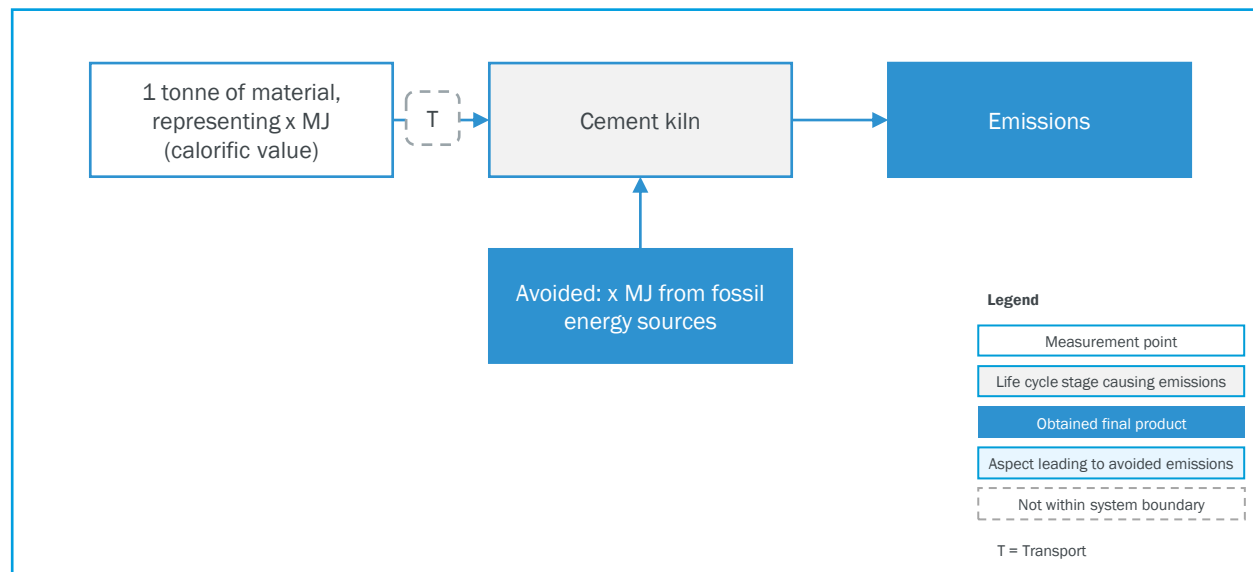

- WDF may be co-incinerated in a cement kiln. Not all materials are suited for co-incineration. CO₂ Factors are provided for plastics, paper/cardboard, tyres and mixed WDF (paper/plastic).
- A combined CO₂ factor is provided for co-incineration: a certain share of waste is attributed to co-incineration in cement kilns, another share to co-incineration in coal-fired power plants.

Avoided emissions

- Co-incineration in a cement kiln avoids the use of fossil energy sources as an energy source, mainly coal and lignite and a small share of fuel oil (<2%) [Merlin & Vogt 2020]. The coal substituted was based on:
 - The lower heating value of the material (for material specific LHVs see Annex - CO₂ Factors: Sources and Explanations).
 - Information on the CO₂ emission per GJ coal incinerated in a furnace: 89,8 kg CO_{2eq}/GJ coal (Emission factors per energy carrier derived from RVO [2020]).
- One CO₂ factor was established for both types of co-incineration. The distribution assumed in this study is:

Co-incineration route	Baseline & Projection 1	Projection 2
Coal fired plants	50%	10%
Cement kilns	50%	90%

Source: [Ecoinvent v.3.6], interviews provided, assessment and calculation by CE Delft

Data modelling – CO₂ factors: Landfilling

System boundaries for landfilling

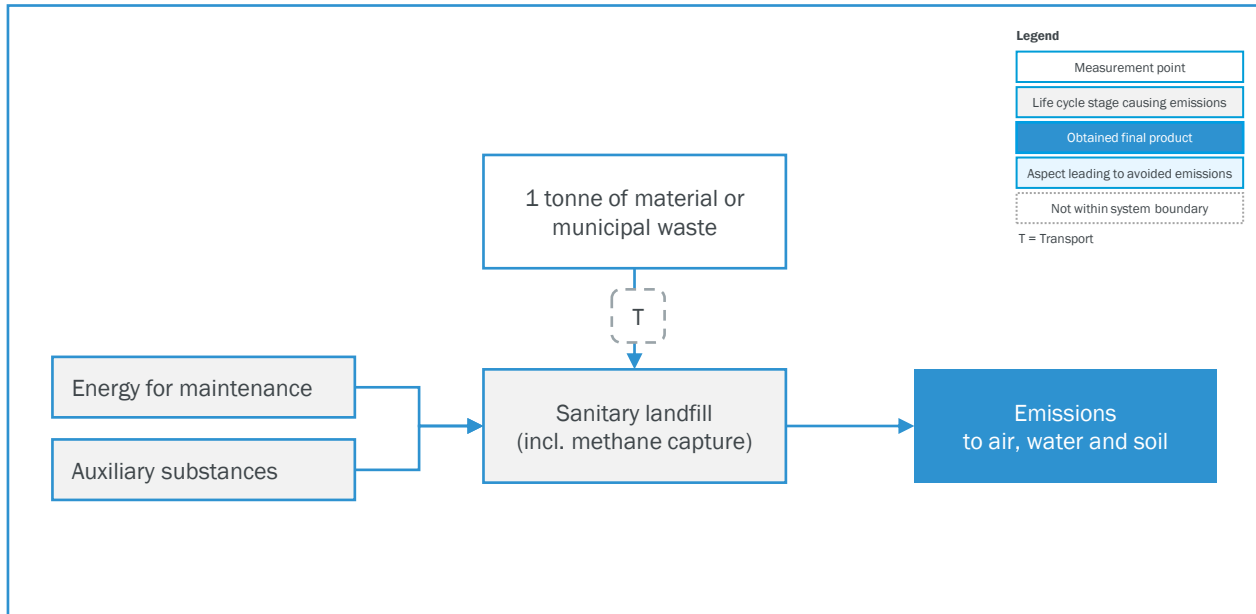

- In this study, the statistical volumes of waste are linked to the CO₂ factors or the processing/treatment of that waste stream.
- For landfilling the CO₂ factors are applicable to 1 metric tonne of material. Factors are provided both for specific materials and for average municipal waste.
- Methane recovery of methane released through the decomposition of biobased materials in landfills is included. It is accounted for in the final emissions to air.
- CO₂-emissions from burned recovered methane are also accounted for.
- For waste tyres a landfill ban is in place since 2003/2006; no CO₂ factor for landfilling of tyres is calculated.

Source: [Ecoinvent v.3.6], assessment and calculation by CE Delft

General explanations

- The impact of landfilling is based on Ecoinvent inventories of materials 'to sanitary landfill'. These Ecoinvent inventories include a methane emission, if relevant to the waste stream, which accounts for methane capture. The datasets, therefore, show the net methane emission. The average methane recovery rate is 53% in the datasets.
- The CO₂ factor for average MSW by Ecoinvent database is compared with a study on methane emissions of MSW landfilling (Wang et al., 2019). This study shows a range in CO₂ emission factors for three methane capturing techniques (passive venting, flaring and energy recovery). The Ecoinvent models represent the average of the several existing techniques. The CO₂ factors (20-year and 100-year time horizon) based on Ecoinvent were found to fall exactly within the range for the flaring technique as reported by Wang et al. The passive venting has a (much) higher CO₂ factor whereas the Energy Recovery has a lower CO₂ factor. The Ecoinvent models are, therefore, considered to be representative for landfilling on average.
- No credit is included for the share of landfill gas energy recovery or other thermal treatment, which additionally avoids fossil CO₂ from conventional energy sources. The percentage of landfills that on average utilize the landfill biogas (energy recovery) is not exactly known but supposed to be small (Interreg/Cocoon 2018). Although this leads to a slight overestimation of the CO₂ factors, they are still within the (uncertainty) range by Wang et al. The avoided methane emission has the most significant effect on the CO₂-equivalence factor.

Data Modelling – CO₂ factors: Waste derived fuel and average residual municipal solid waste

Waste derived fuel

- Waste derived fuel (WDF), sometimes referred to as refuse derived fuel or solid recovered fuel, is a fuel that is produced from a mixed waste stream such as from municipal solid waste or residual fractions from sorting and recycling processes. WDF is processed mostly in waste-to-energy plants but is partly also co-incinerated in coal-fired plants or cement kilns.
- This study considered the available capacities in WtE and co-incineration facilities and derived waste stream specific assumptions for the respective allocation, which lead to an average distribution across Europe of about 75% of the WDF to be processed as by WtE plants and 25% as by co-incineration. They were estimated based on the estimated available national plant capacities of WtE and co-incineration.

Residual municipal solid waste

- Residual municipal solid waste (MSW) is a heterogenous mix of materials, which gets landfilled or incinerated in a WtE plant. The CO₂ factor of average residual municipal solid waste was based on the (calculated) average composition of the MSW, and the respective CO₂ factors per waste stream. For details see the Annex - CO₂ Factors: Sources and Explanations.
- As for all datasets, transport is excluded from the calculation.

Source: [Ecoinvent v.3.6], interviews provided, assessment and calculation by CE Delft

Role of carbon capture, utilisation & storage (CCUS)

Additional potential from CCUS in industrial sectors

- Carbon capture is a technical solution that is considered a necessity in order to reach the GHG emission reduction goals of the Paris agreement. The captured carbon can be stored (CCS) or utilized as fuel or feedstock for products (CCU). According to the global CCS institute in Europe* 42 commercial CCS facilities are currently planned or under development to become operational between 2024 and 2030. Three commercial CCS plants are currently in operation, as well as eight pilot/demonstration facilities. The planned, commercial CCS facilities are applied to WtE plants, cement production, power generation, natural gas processing, hydrogen production and chemical/fertilizer production.
- Facilities operating today capture around 90% of the CO₂ from the flue gas, and future plants could be designed to capture 99% or more [IEA, 2020].
- Capturing CO₂ reduces the CO₂ emission of a facility but also leads to GHG emissions. Capturing CO₂ requires energy and requires using auxiliary substances (chemicals). For CCS, energy for storage activities and CO₂ leakage during transport also lead to emissions. Multiple LCA studies on CCS that take into account the upstream and downstream effects conclude that CCS leads to a net CO₂ reduction e.g. [IEAGHG, 2020], [Raadal and Modahl, 2021], [CE Delft, 2018], [Marx et al, 2011].
- For CCU [Raadal and Modahl, 2021] and [CE Delft, 2018] conclude that recycling CO₂ into fuel is not a sustainable way to move forward, as the captured CO₂ is re-emitted after going through energy intensive processes. In [CE Delft 2018] application in greenhouses (horticulture) and mineralization lead to a net CO₂ reduction. Both studies conclude that a net emission increase occurs for methanol production if fossil energy is used for this production. This means that the GHG emissions for methanol production out of CO₂ (by means of fossil fuels) are higher than the CO₂ reduction of the captured CO₂. It thus depends on the application whether CCU leads to CO₂ reduction or not.

Additional potential of CCUS in energy recovery from waste

- Within the scope of this study, CCS, and in certain applications CCU, could lower the CO₂ emissions of WtE plants, cement kilns, and conventional power plants. This will lower the emissions of waste incineration and co-incineration. Application of CCS/CCU at conventional fossil-based power plants and at natural gas processing plants would also have a lowering effect on the avoided emissions of incineration in a WtE facility, because CCS/CCU would lower the CO₂ emission of conventional heat and power.
- Because of various uncertainties the effect of CCS and CCU cannot be quantified in this study:
 - It is hard to estimate to what degree CCS and/or CCU in 2035 will be deployed at WtE plants, cement kilns, and/or conventional (fossil based) power plants.
 - The CO₂ reduction effect strongly depends on the choice of CCS or one of the possible utilization routes (CCU).
 - Within the scope of this study, CO₂ reductions may occur due to CCS/CCU at WtE plants, cement kilns, and coal-fired power plants. At the same time large-scale application in the heat and power sector would reduce the avoided emissions from waste incineration in WtE plants. The net effect on the CO₂ factors is, therefore, unknown.
 - The integration of CCUS technologies in WtE facilities could be an extra tool to further reduce the carbon footprint of the Energy Recovery/other thermal treatment sector in the future.

* Including Norway and the UK

Sources: [IEA, 2020], [IEAGHG, 2020], [Raadal and Modahl, 2021], [CE Delft, 2018], [Marx et al, 2011], assessment CE Delft



© iStock - diephosi

Sensitivities

P

100-years perspective

The time horizon selected for greenhouse gas effects in the atmosphere in this study is 20-years to better reflect urgency and in particular the short-term climate impacts of methane emissions. A sensitivity with a 100-years perspective was applied, which is the common international standard.

M

20-years marginal approach

A marginal approach means that the energy generated at WtE plants avoids the most carbon intensive conventional power generation technologies – fossil fuel sources – instead of the average electricity and heat mix that also contains renewable energy. This sensitivity focuses on the effect of such an energy mix being replaced by energy recovery treatment from waste.

D

Derogation option

For fulfilling the landfill and recycling targets for municipal waste a derogation option can apply to Member States. In this sensitivity the effect without the derogation option is calculated.

T

Transport emissions

Given the limited data and carbon impact of mainly transboundary movements, transport emissions were disregarded. A sensitivity incl. transport emissions is simulated for residual wastes/WDF (as defined by this study) in Chapter 6.

Sensitivities: GWP Comparison

CO_{2eq} Emissions by Global Warming Potential

- The 100-years perspective is the common GWP time horizon standard for national and international studies.
 - Greenhouse gas emissions, of especially higher potential such as methane, and their warming potential are spread over a 100-year timeframe.
- The time horizon for greenhouse gas effects in the atmosphere in this study is a 20-years perspective.
 - “Just like the 100-year GWP is based on the energy absorbed by a gas over 100 years, the 20-year GWP is based on the energy absorbed over 20 years. This 20-year GWP prioritizes gases with shorter lifetimes, because it does not consider impacts that happen more than 20 years after the emissions occur. Because all GWPs are calculated relative to CO₂, GWPs based on a shorter timeframe will be larger for gases with lifetimes shorter than that of CO₂, and smaller for gases with lifetimes longer than CO₂. For example, for CH₄, which has a short lifetime, the 100-year GWP of 28–36 is much less than the 20-year GWP of 84–87. For CF₄, with a lifetime of 50,000 years, the 100-year GWP of 6630–7350 is larger than the 20-year GWP of 4880–4950.” [EPA 2021].
 - For a comparison of the different GWP per time frame and greenhouse gas, please see the Global Warming Potentials, IPCC second assessment [UNFCCC 2021]
 - The 20-year time horizon better represents the so-called ‘individualistic’ point of view of humans, i.e. emissions effect the lives of the currently living people (most), and climate change can be technologically solved and adapted to. It provides a perspective stressing greater urgency. Consequently, it was chosen as the default for this study.
- The marginal approach is a complementary 20-year perspective in which the most carbon intensive power generation technologies – fossil fuel sources – are avoided instead of the average mix. It allows for a better comparison of a situation in which priority is given to the substitution of conventional energy sources in the energy network.

Sources: [EPA 2021], [UNFCCC 2021]

Results by different GWP perspectives in Mt CO_{2eq}

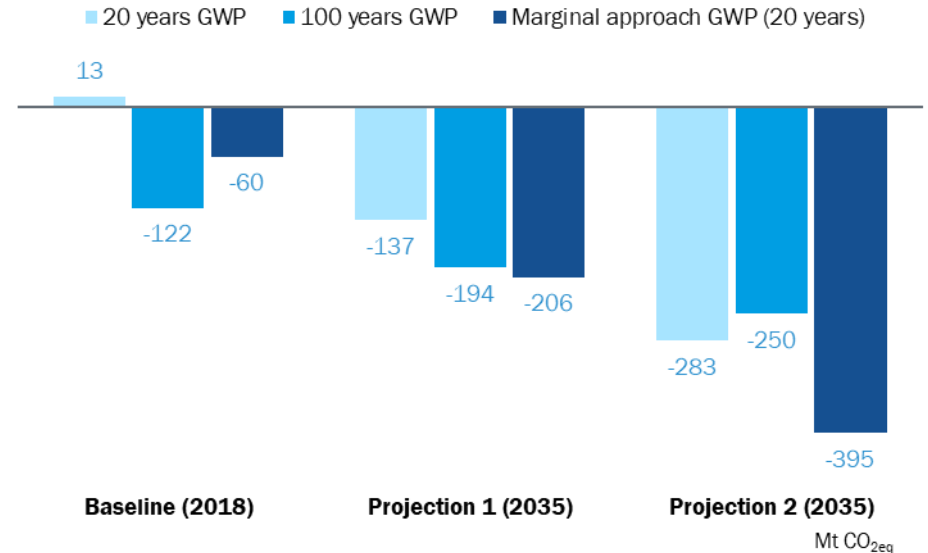

- The comparison of the results reflect these differences (see figure above). The 20-year perspective with a significantly higher methane factor results in higher CO_{2eq} emissions compared to the 100-year perspective up to the point where methane emissions from landfilling are substantially lowered.
- The marginal approach, which accounts the avoidance of a fossil-fuel-based energy mix, shows correspondingly a higher avoidance than the 20-year perspective based on an actual average energy mix representative of the European grid including renewable energy.
- The detailed results are discussed in the following result chapters.

Overview of Main Results

04



Total Material Waste Streams*

Source © Fotolia - giannip

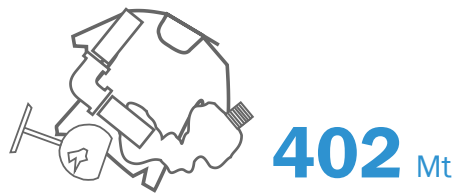

Key results

Material waste streams' volume*

402 Mt of estimated waste generated and statistically recorded within the EU 27+UK in 2018. Corresponding to an average of 784 kg per inhabitant. In weight, ferrous metal (101 Mt), paper (79 Mt) and wood (67 Mt) constitute the largest amongst the 9 selected material waste streams.

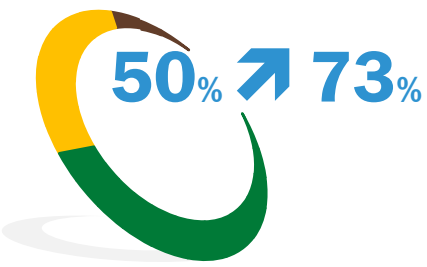

Material recycling

In 2018, approx. 50% (201 Mt) were recycled and 28% (114 Mt) were energy recovered/otherwise thermally treated**. In the projections, the total material recycling rate was estimated to achieve ~73% by 2035, corresponding to approx. 295 Mt. By decreasing the allocated amount to landfilling, in the more ambitious Projection 2, approx. 104 Mt will be energy recovered/otherwise thermally treated.

CO₂ emission savings



While in 2018 the net CO₂ emission burden amounted to -96 Mt CO_{2eq}, in Projection 1 it falls to -235 Mt CO_{2eq} in 2035. This is primarily the result of a lowered allocation to landfilling. By further avoiding landfilling of waste, net emissions of approx. -267 Mt CO_{2eq} are achieved by 2035 in Projection 2. -6 Mt CO_{2eq} of additional potential exists in treating currently unknown treated plastic and textiles wastes in the EU as in Projection 2.

*for the allocated EWC-Codes please refer to Annex EWC-Codes
**at point of measurement after sorting
*material waste streams, i.e. all material streams considered in this study (paper & cardboard, glass, plastic, ferrous metal, aluminium, wood, textiles, biowaste, tyres) i.e. except residual waste/WDF

Material waste stream totals

 **402**
Mt/2018

 **784**
kg/ihh (2018)

Waste Management Route

■ Recycling (output rate) ■ Energy Recovery/other thermal treatment ■ Landfilling ■ Treatment unknown (all figures in Mt)

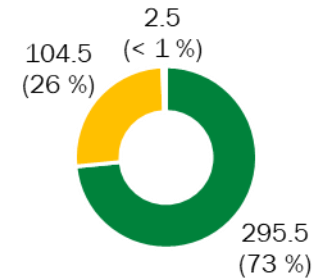
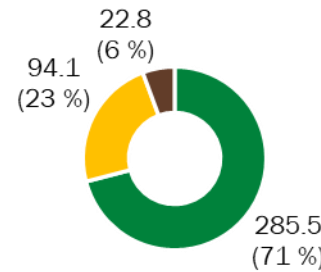
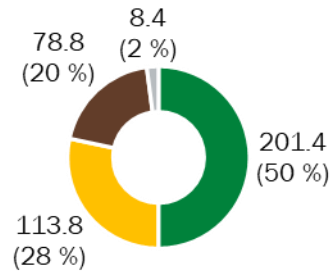

CO_{2eq} Net Emissions

■ Total CO_{2eq} Net Emissions per year ■ CO_{2eq} from unknown treatment (all figures in Mt CO_{2eq})

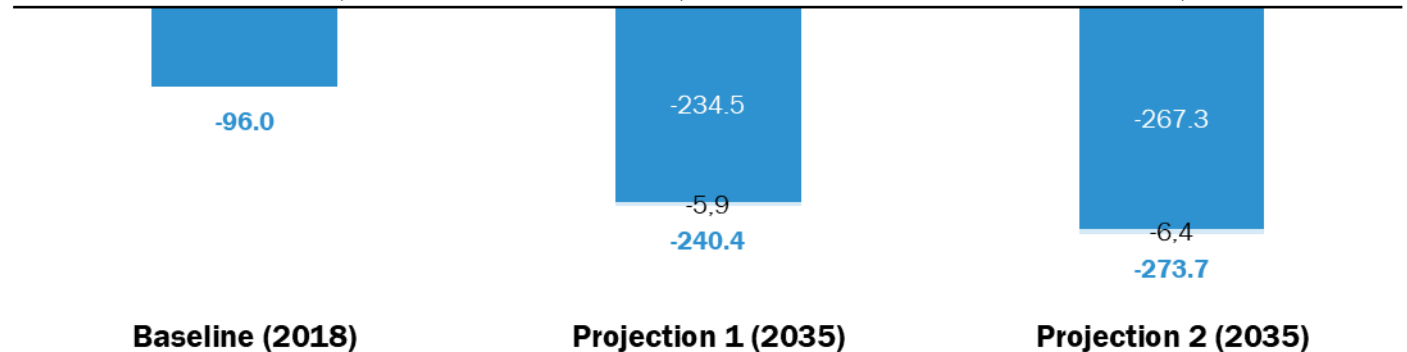

Key results

- An increase in recycling rate from 50% (201 Mt) to 73% (296 Mt) and a decrease in landfill from 20% (79 Mt) to below 1% (<3 Mt) is estimated in Projection 2.
- The resulting net CO₂ emissions fall from -96 Mt to -267 Mt CO_{2eq} by 2035 in Projection 2. -6.4 Mt CO_{2eq} of additional potential exists in treating currently unknown treated plastic and textiles wastes in the EU as in Projection 2.

Projection 1 waste targets incl. derogation option. Projection 2 does not consider contingency capacities for landfilling or other wastes requiring landfilling. Treatment unknown not included in Baseline CO₂ estimation. In projections assumed to be treated as in EU, and separately indicated. Recycling figures relate to output rates after sorting losses, in accordance with the legislative point of measurement. 20-year time horizon for greenhouse gas effects in the atmosphere, excl. transport.

Sources: Eurostat, ETRMA, various sources of bibliography; assessment and calculation by Prognos and CE Delft

Sources: Eurostat, ETRMA, various sources of bibliography; assessment and calculation by Prognos and CE Delft

Material waste stream totals

Waste material and CO₂ reduction potential to protect the climate

- Amongst the material waste streams (402.5 Mt), ferrous metal (25%), paper & cardboard (20%), and wood (17%) are the largest.
- Paper & cardboard (76 Mt CO_{2eq}), biowaste (37 Mt CO_{2eq}), and plastics (1 Mt CO_{2eq}) have a net CO₂ burden.
- Ferrous metal (-121 Mt CO_{2eq}), aluminium (-59 Mt CO_{2eq}) and wood (-23 Mt CO_{2eq}) have net CO₂ savings (i.e. a negative burden) in the baseline.
- Considering the material waste streams, an increase in recycling rate from 50% (201 Mt) to 73% (296 Mt) is estimated along with a decrease in landfill from 20% (79 Mt) to below 1% (<3 Mt) in Projection 2.
- The **CO₂ burden in the Baseline** is estimated at
 - -96 Mt CO_{2eq} (excl. unknown treatment) falls to:
 - -235 Mt CO_{2eq} in Projection 1 (excl. unknown treatment)
 - -267 Mt CO_{2eq} in Projection 2 (excl. unknown treatment)with an additional potential of around -5.9 to -6.4 Mt CO_{2eq} by treating the unknown treated wastes as in the EU Projection 1 and 2.
- The amount allocated to energy recovery/other thermal treatment decreases from the Baseline to Projection 1 (28% to 23%), but increases in Projection 2 to 26% (104 Mt) as previous volumes allocated to landfill are re-allocated to recycling and energy recovery/other thermal treatment.
- **Primary drivers of the CO₂ reduction:**
 - Reduction of organic fractions allocated to landfill are the principal driver of the significant CO₂ reduction, especially in the waste streams paper & cardboard and biowaste.
 - Additional large reductions result from the decreased volumes and improvements in the CO₂ factors of co-incineration by avoided emissions in Projection 2.
 - However, also the increased recycling volume increases avoided emissions.
- **20 vs 100-year time horizon**
 - The 100-year time horizon has a lower net CO₂ emissions than in the 20-year time horizon in the Baseline and in Projection 1:
 - Baseline: -96 vs -171 Mt CO_{2eq}
 - Projection 1: -240 vs -243 Mt CO_{2eq} (incl. unknown treatment)
 - Projection 2: -274 vs -255 Mt CO_{2eq} (incl. unknown treatment)
 - The stark difference is driven by landfilling of especially the organic materials which have a factor that is much higher in the 20-year time horizon and cannot compensate the also larger net avoidance from recycling and energy recovery/other thermal treatment. In Projection 2, this relationship is inverted with more immediate larger avoidance from recycling and energy recovery/other thermal treatment.
- 20-year time horizon **vs the 20-year time horizon marginal approach** is pronounced
 - Baseline: -96 vs -152 Mt CO_{2eq}
 - Projection 1: -240 vs -288 Mt CO_{2eq} (incl. unknown treatment)
 - Projection 2: -274 vs -341 Mt CO_{2eq} (incl. unknown treatment)
- The exclusion of the **derogation option** does not have a noteworthy effect on the totals at the European level. This is also the case for the individual waste streams of the study.
- Transport is not included.



Total Residual wastes/WDF*

Source: Ralf Breer



237 ↘ 190 Mt

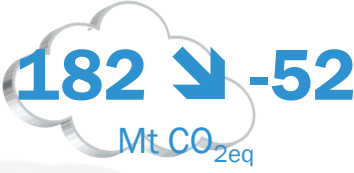
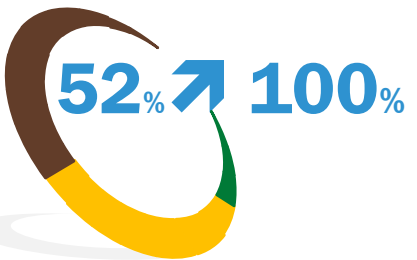

Key results

Residual Waste/WDF's volume

237 Mt⁺⁺⁺ of estimated waste derived fuels and residual waste are generated and statistically recorded within the EU 27+UK in 2018, corresponding to an average of 462 kg per inhabitant. The residual wastes/WDF in this study are comprised by sorting residues (W103), municipal residual wastes (non-recycled municipal waste), and sorting and recycling losses from the selected material waste streams. The material waste stream projections, thus, influence waste volumes of the residual wastes/WDF.

Energy Recovery/other thermal treatment

In 2018, approx. 52% (123 Mt) residual wastes/WDF were energy recovered/otherwise thermally treated^{***}. The remainder is allocated to landfill. In Projection 2 fractions suitable for thermal treatment are no longer allocated to landfill. Landfilling of specific residual wastes/WDF that remain necessary in the future (e.g., after flood disasters) are not part of this study.

CO₂ emission savings

While in 2018 the net CO₂ emission burden amounted to 182 Mt CO_{2eq}, in Projection 1 it falls to Mt 120 CO_{2eq} in 2035. This is also a result of less residual wastes/WDF being available, as more wastes are sorted out for recycling. By allocating residual wastes/WDF to Energy Recovery/other thermal treatment in Projection 2, the CO₂ emissions falls to -52 Mt CO_{2eq}.

^{***} Overlap with material waste streams results from the non-recycled municipal waste part, and sorting and recycling losses.
^{*}residual wastes/WDF refers to the waste derived fuels and residual waste as defined in the Annex for the allocated EWC-Codes please refer to Annex EWC-Codes

Residual waste and waste derived fuels totals



Key results

- Residual waste/WDF include the sorting losses from the selected waste streams and non-recycled municipal waste. The amount, therefore, changes with the projections: new sorting losses are added, and residual waste reduced, as more municipal residual waste are recycled. This interaction lets the residual waste volume decline overall.
- Combined with the increased amount allocated to Energy Recovery/other thermal treatment, the net CO₂ emissions substantially fall from 182 Mt CO_{2eq} in the Baseline to -52 Mt CO_{2eq} in the Projection 2.
- Landfilling of specific residual wastes/WDF will still be necessary (e.g. asbestos). Such specific waste streams are not part of the scope of this study. Certain contingency planning capacities will also be needed, which has also not been considered. A complete discontinuity of landfilling is not realistically possible.

* year refers to the projection year, while the waste volume is held constant at the level of 2018.
Sources: Eurostat, various sources of bibliography; assessment and calculation by Prognos and CE Delft

Waste Management Route

■ Recycling (output rate) ■ Energy Recovery/other thermal treatment ■ Landfilling (all figures in Mt)

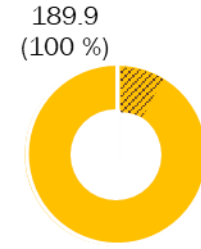
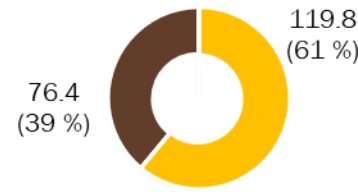
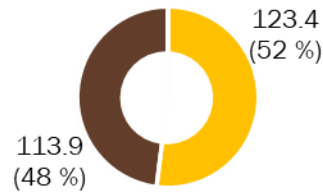

i As the statistical category „sorting residues“ contains also smaller amounts of waste types, which may not be suitable for Energy Recovery/other thermal treatment, landfilling will remain needed. It is not included in the presented calculation and only marked up indicatively.

CO_{2eq} Net Emissions

■ Total CO_{2eq} Net Emissions per year (all figures in Mt CO_{2eq})

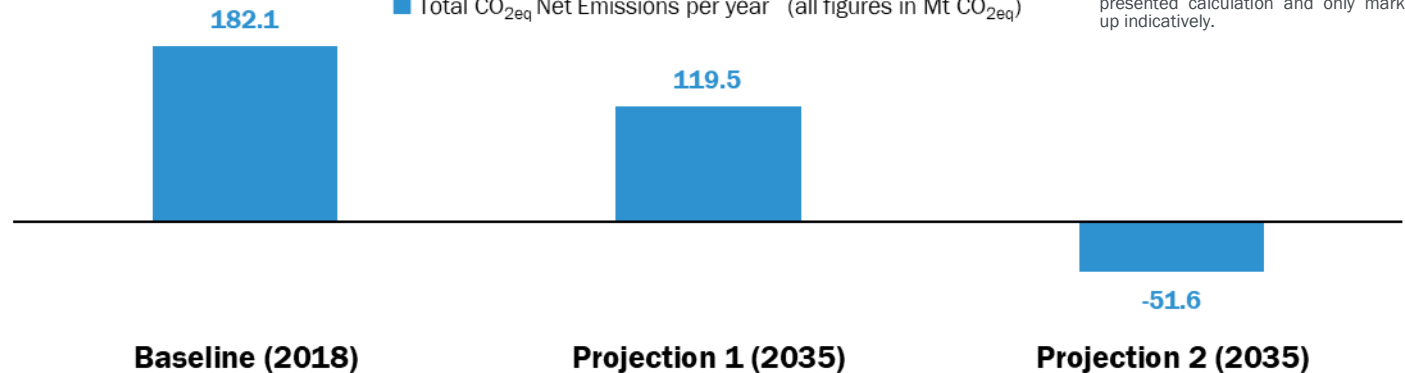

Projection 1 waste targets incl. derogation option. Projection 2 does not consider contingency capacities for landfilling or other wastes requiring landfilling. Treatment unknown not included in Baseline CO₂ estimation. In projections assumed to be treated as in EU, and separately indicated. The overall waste volume marginally decreases as other material wastes (not covered) in the municipal waste are also recycled, which in turn lowers the modelled waste volume amount and, therewith, the considered residual wastes/WDF, while the selected material waste stream volume is held constant. The overlap with material waste streams is included in these figures. They cannot be added together with the figures for the material waste streams, thus are provided as a separate combined total (slide 51-54).

Residual waste and waste derived fuels totals

Energy recovery/other thermal treatment and CO₂ reduction potential to protect the climate

- The total amount of residual wastes/WDF decreases from 237 Mt to 190 Mt. With increasing recycling of the selected waste streams more residual waste in form of sorting and recycling losses are generated, which are included in the waste derived fuels. At the same time, with increased volumes being recycled other residual wastes decrease, while additional recycling losses are generated.
- The included residual wastes/WDF (waste derived fuels and residual wastes) are comprised by sorting residues (W103), paper sludges not suitable to be considered under paper & cardboard material waste stream, municipal residual wastes (non-recycled municipal waste), and the sorting and recycling losses from the selected material waste streams.
- Given their difference in quality and, thus, treatment routes (e.g. lower calorific value to WtE plants, higher calorific value to cement kilns), different treatment routes were allocated. Hereby it was not considered that residual wastes/WDF that arise from high calorific value WDF production are landfilled.
- With the increase in the energy recovery/other thermal treatment rate from 52% (123 Mt) to 61% (120 Mt) to a complete allocation to energy recovery/other thermal treatment with 190 Mt, substantial net CO₂ emissions can be avoided. The most CO₂ savings arise from not allocating the residual wastes to landfilling. Given the different energy recovery/other thermal treatment routes, the modelled net CO₂ emission avoidance remain in sum modest, although higher for energy recovery/other thermal treatment by co-incineration. Consideration is given to the fact that a fraction of those residual wastes/WDF, variable across EU, not suitable for combustion according to national rules, will still need to be allocated to landfills.
- The net CO₂ burden in the Baseline is estimated at
 - 182 Mt CO_{2eq} and falls to
 - 120 Mt CO_{2eq} in Projection 1
 - -52 Mt CO_{2eq} in Projection 2
- **Primary drivers of the CO₂ reduction:**
 - The net CO₂ savings are a result of a reduced allocation to landfill. This is particularly pronounced in the shift from Projection 1 to Projection 2.
 - Also less residual wastes/WDF are available, as more wastes are sorted out for recycling, which affect the CO₂ emissions.
 - Changing CO₂ factors interplay between the allocated fractions to incineration and co-incineration, which also affect the emissions.
- **20 or 100-year time horizon**, has a noticeable effect
 - Baseline: 182 vs 59 Mt CO_{2eq}
 - Projection 1: 120 vs 41 Mt CO_{2eq}
 - Projection 2: -52 vs -32 Mt CO_{2eq}
- The effect of the 100-year perspective is primarily the result of the CO₂ factor for landfill, which is lower in the 100-year perspective, as the emissions' effect in atmosphere is spread over a longer time period. This is also the case for energy recovery/other thermal treatment, which explains higher avoidance in the 20-year perspective than the 100-year time horizon (see Projection 2).
- **20-year time horizon vs the 20-year time horizon marginal approach** has an even stronger contrast highlighting the benefits of energy recovery/other thermal treatment of waste compared to fossil fuel-based energy.
 - Baseline: 182 vs 140 Mt CO_{2eq}
 - Projection 1: 120 vs 71 Mt CO_{2eq}
 - Projection 2: -52 vs -141 Mt CO_{2eq}



Combined totals of Material wastes + Residual/WDF waste

Source © Fotolia - Alexey Zarodov

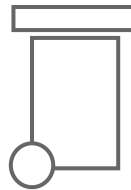

505 Mt

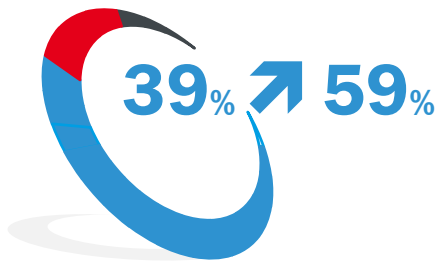

Key results

Combined totals of Material + Residual/WDF waste streams' volume

505 Mt of estimated waste generated and statistically recorded within the EU 27+UK in 2018. This study covers, therefore, only ~19 % of the total waste generated (2.6 Bt) in the EU27+UK recorded by Eurostat and corresponds to an average of 985 kg per inhabitant. In weight, ferrous metal (101 Mt), paper (79 Mt) and wood (67 Mt) constitute the largest amongst the 9 selected material waste streams.

Material recycling

In 2018, approx. 39% (201 Mt) were recycled, increasing to 59% in the more ambitious projection**. Considering only the material waste streams selected for this study, the recycling share climbs from 50% to 73% by 2035, corresponding to approx. 296 Mt. While the municipal solid waste landfill target is achieved (<10%) in projection 1, the indicated 14 % landfill is the result of the large amount from the sorting residues (W103) not covered by any legislative target.

CO₂ emission savings

While in 2018 the net CO₂ emissions amounted to 13 Mt CO_{2eq}, in Projection 1 it falls to -137 Mt CO_{2eq} in 2035 (incl. unknown treatment). This is primarily the result of a lowered allocation to landfilling. By further avoiding landfilling of waste, net emissions of approx. -283 Mt CO_{2eq} can be achieved by 2035 in Projection 2 of which -6 Mt CO_{2eq} originate from treating the unknown treated plastic and textiles wastes in the EU.

*for the allocated EWC-Codes please refer to Annex EWC-Codes
**at point of measurement after sorting

Combined totals of material waste streams and residual wastes/WDF

Guidance for the interpretation of the combined total of the material waste streams and residual wastes/WDF

- The next figure and the slides 55-59 show the waste volume potentials by treatment route and potential CO_{2eq} avoidance for the combined totals of material waste streams and residual wastes/WDF of this study.
- It is important to note that in these combined totals of the selected waste streams (i.e. material waste streams and residual wastes/WDF), the landfill and recycling targets in the waste management cannot be identified. The minimum recycling target of 65% (after sorting) and maximum landfill target of 10% after the output-based measurement point of recycling are, however, met in projection 1.
- The following diagram (slide 53) shows the combined total of the waste streams covered by this study, which includes a large volume of still occurring sorting residues. Since residual wastes include sorting and recycling residues (W103 - see Annex EWC Codes), in this representation, recycling (output rate) percentages appear lower and landfill percentages appear higher. In order to properly identify recycling and landfill targets, please refer to slide 48, which considers only the material waste streams selected for this study.
- Furthermore, energy recovery covers not only Waste-to-Energy incineration of residual waste treatment, but also other types of thermal treatments such as co-incineration (e.g. in cement kilns), combustion of wood (hazardous and non-hazardous) in dedicated bio-energy plants for heat and/or power production, etc.
- With regards to Projection 2 it is also important to note, that as the statistical category „sorting residues“ (W103) contains also smaller amounts of waste types, which may not be suitable for energy recovery, landfilling will remain needed. It is not included in the presented calculation and only marked up indicatively.
- As already indicated in the methodology, the waste generation amount is held constant at 2018 levels for a clearer comparison among the projections. Important developments in waste prevention or eco-design and similar will favor a decrease in waste generation in the next years. On the other hand, population and GDP growth, demographic change, among other could increase waste generation. These dynamics are not modelled and need to be born in mind.
- As highlighted in the methodology, in particular for the pronounced cases of plastic and textiles, the figures reported also include some quantities likely treated outside the EU27+UK. These arise due to the data gaps between waste treated and waste generated despite considering import/export flows. Here it applies to the Baseline and to the projections and is not separately indicated.
- Net emissions are the sum of emissions produced by treating the waste material and avoided by producing, for example, recycled secondary materials or energy, thereby saving emissions elsewhere.

Combined totals of material waste streams and residual wastes/WDF



~505

Mt/year*



~985

kg (year)/ihn (2018)

Waste Management Route

■ Recycling (output rate) ■ Energy Recovery/other thermal treatment ■ Landfilling ■ Treatment unknown (all figures in Mt)

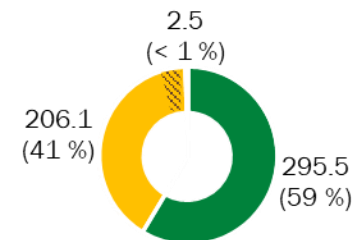
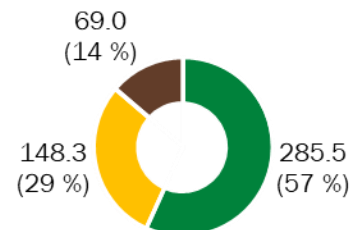
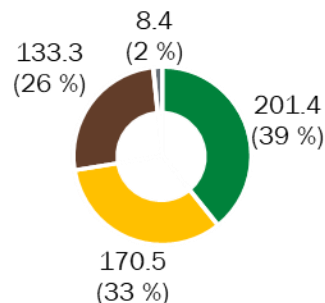

i Minimum recycling target of 65% (after sorting) and maximum landfill target of 10% are met, but after the measurement point of recycling still sorting and recycling residues arise. Therefore, in this representation, recycling (output rate) percentages appear lower than 65% and landfill percentages appear higher than 10%.

i As the statistical category „sorting residues“ contains also smaller amounts of waste types, which may not be suitable for Energy Recovery/other thermal treatment, landfilling will remain needed. It is not included in the presented calculation and only marked up indicatively.

CO_{2eq} Net Emissions

■ Total CO_{2eq} Net Emissions per year (all figures in Mt CO_{2eq})

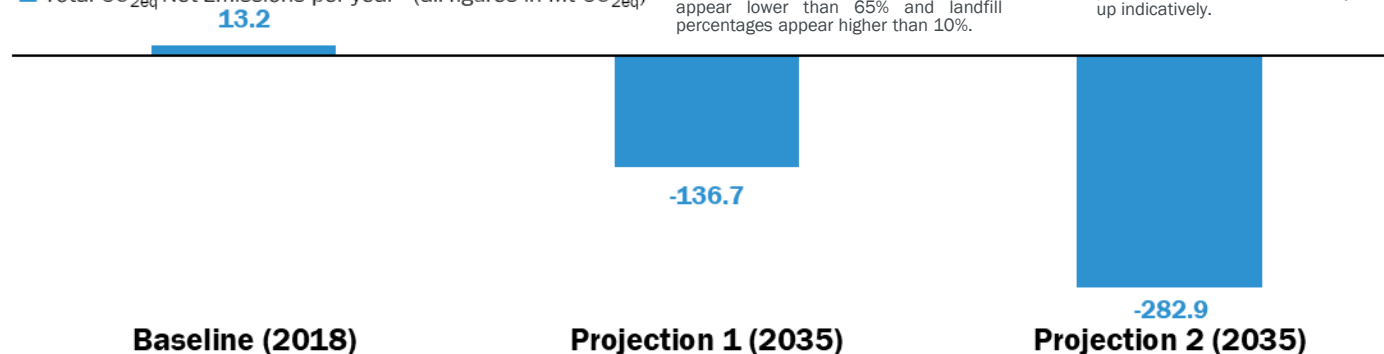

Projection 1 waste targets incl. derogation option. Projection 2 does not consider contingency capacities for landfilling or other wastes requiring landfilling. Treatment unknown is not included in Baseline CO₂ estimation (est. <<1Mt CO_{2eq}). In the projections it is included and assumed to be treated as in EU + UK. Recycling figures relate to output rates after sorting losses, in accordance with the legislative point of measurement. 20-year time horizon for greenhouse gas effects in the atmosphere, excl. transport. The overall waste volume marginally decreases as other material wastes (not covered) in the municipal waste are also recycled, which in turn lowers the modelled waste volume amount and, therewith, the considered residual wastes/WDF, while the selected material waste stream volume is held constant. The overall amount considered is held constant, while the overlap decreases. Residual wastes include sorting residues (W103) (see Annex EWC Codes). This lowers in the overall results the recycling rate and increases the landfill rate. While the municipal solid waste landfill target is achieved (<10%) in projection 1, the indicated 14% landfill is the result of the large amount from the sorting residues (W103) not covered by any legislative target.

Key results

- The ring diagrams (left to right) show an increase in waste volume being recycled, while landfilling is significantly reduced. The percentages indicated in the ring diagrams do not show the achievement of the recycling and landfill targets, due to the presence of residual wastes from sorting and recycling (especially, W103 - see Annex EWC Codes).
- Below the ring diagrams, the bars show the equivalent net CO_{2eq} emissions from the treatment routes.
- The Baseline produces net CO_{2eq} emissions of 13 Mt CO_{2eq}. From a net burden, the projections result in a net-saving of between -137 to -283 Mt CO_{2eq} in Projection 2.

Sources: Eurostat, ETRMA, various sources of bibliography; assessment and calculation by Prognos and CE Delft

Volume and CO₂ net emissions by material waste stream and residual wastes/WDF

Baseline

 **505**
Mt/2018

Key results

- The left bar chart shows the total waste volume and share in the total waste volume (505 Mt incl. unknown treatment) of the selected waste streams.
- Ferrous metal (101 Mt), paper (79 Mt) and wood (67 Mt) represent the largest of the selected material waste streams (excl. residual wastes/WDF).
- The right diagram shows their net emissions in 2018 in Mt CO_{2eq}. Paper, due to its organic matter in landfilling, has the largest net-burden (76 Mt CO_{2eq}) (excl. residual wastes/WDF).
- Ferrous metal has the highest net-avoidance (-121 Mt CO_{2eq}). The large amount of recycling avoids significant emissions from producing new ferrous metal.
- Residual wastes/WDF, includes a sizable overlap with the other waste streams (see Chapter 3)⁺⁺. It accounts for a large net burden, due to a large amount being landfilled.

Total Waste Volume by Material Waste Stream and Residual Waste/WDF in 2018 in Mt
(% in total, 505 Mt)

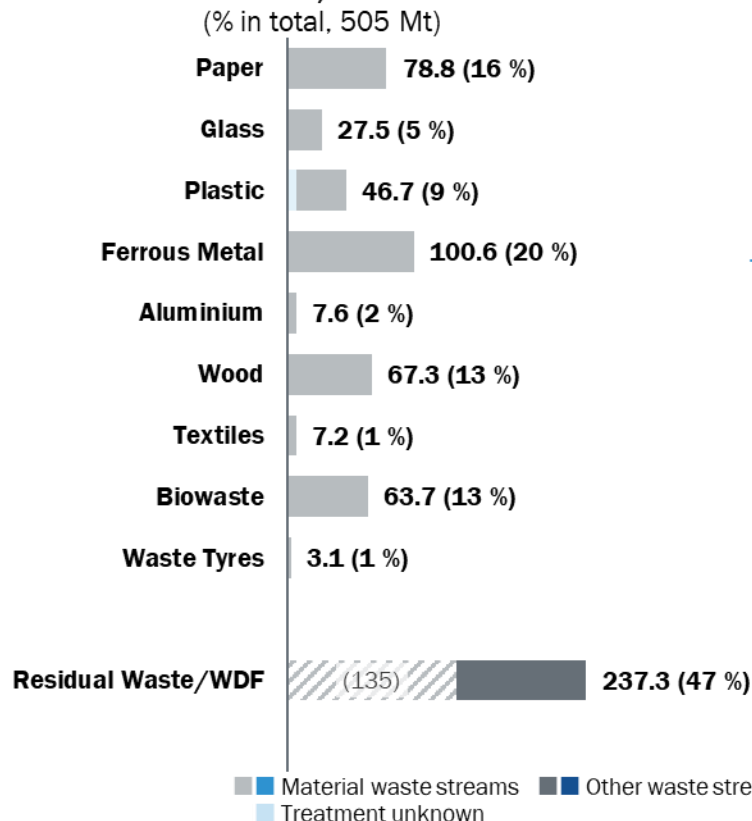

Total Net CO_{2eq} Emissions by Material Waste Stream and Residual waste/WDF in 2018 in Mt CO_{2eq}
(excluding unknown treatment)

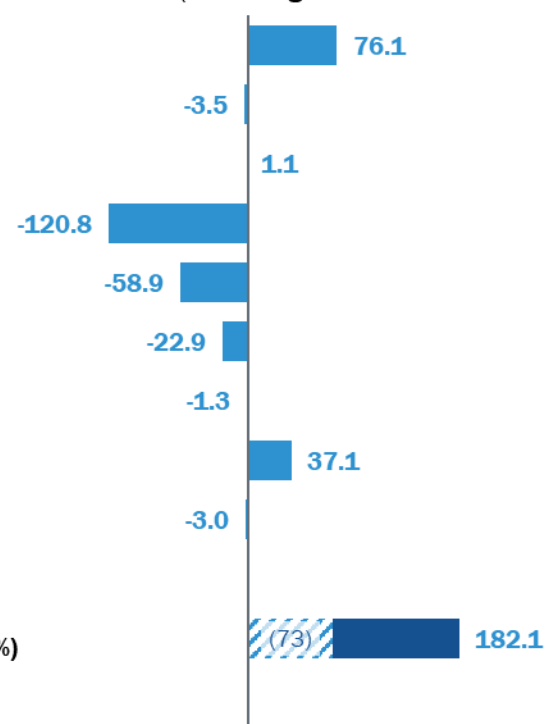

Treatment unknown for plastics and textiles waste not included in Baseline Net CO₂ emissions. For comparability they are marked in the waste volume. Excluding the unknown treatment plastic has a waste volume of 38.9 Mt and Textile 6.6 Mt. In the projections the unknown treatment is assumed to be treated as in EU. CO₂ emissions based on a 20-year time horizon for greenhouse gas effects in the atmosphere, excl. transport.
⁺⁺ Overlap: Sorting and recycling losses, and non-recycled municipal waste feature in the material waste streams and residual wastes/WDF (waste derived fuels and residual waste) and are marked up as the overlap. The total 505 Mt exclude the double counting. Percentages thus add up to >100%. The overlap for net CO_{2eq} emissions are comprised of positive and negative values.

Sources: Eurostat, ETRMA, various bibliographic sources; assessment and calculation by Prognos and CE Delft

Volume and CO₂ net emissions by material waste stream and residual wastes/WDF

Projection 1



503

Mt/2035

Total Waste Volume by Material Waste Stream and Residual Waste/WDF in 2035 (Projection 1) in Mt
(% in total, 503 Mt)

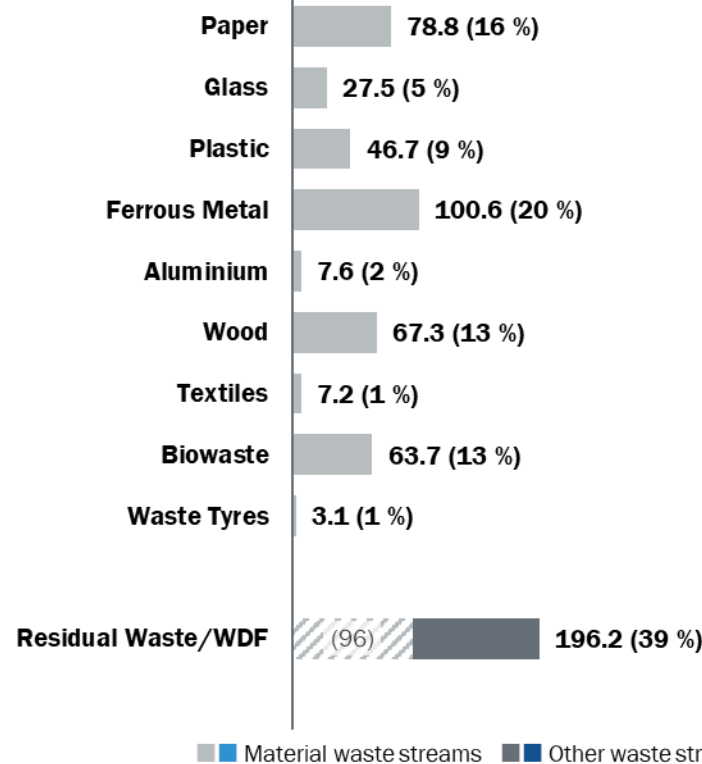

Total Net CO_{2eq} Emissions by Material Waste Stream and Residual Waste/WDF in 2035 (Projection 1)
in Mt CO_{2eq}

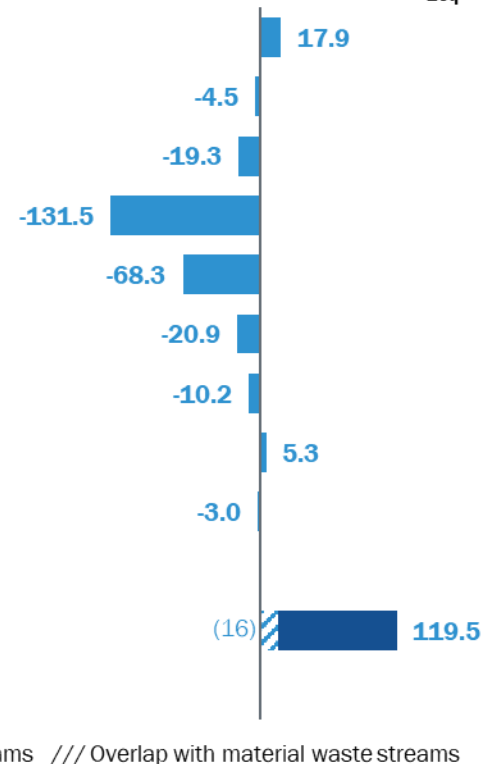

Projection 1 waste targets incl. derogation option. Treatment unknown not included in Baseline CO₂ estimation. In projections assumed to be treated as in EU. 20-year time horizon for greenhouse gas effects in the atmosphere, excl. transport.

*** Overlap: Sorting and recycling losses, and non-recycled municipal waste feature in the material waste streams and residual wastes/WDF (waste derived fuels and residual waste) and are marked up as the overlap. The total 503 Mt exclude the double counting. Percentages thus add up to >100%. The overlap for net CO_{2eq} emissions are comprised of positive and negative values.

Key results

- The net emission burden of paper and biowaste decrease the most compared to the Baseline, as a result of the lower amount being landfilled.
- The residual wastes/WDF constitute the largest net CO_{2eq} emission burden, due the remaining high share allocated to landfill. The waste volume decreases as more waste is recycled, but also increases due to higher losses associated with more recycled waste^{***}.

Sources: Eurostat, ETRMA, various sources of bibliography; assessment and calculation by Prognos and CE Delft

Volume and CO₂ net emissions by material waste stream and residual waste/WDF

Projection 2



504
Mt/2035

Key results

- In Projection 2, net CO₂ emission avoidance is higher than emissions produced by the waste treatment across all waste streams.
- This is a result of an increased share being recycled, but especially by not allocating wastes suitable for recycling and recovery to landfill.
- Compared to the Baseline, the greatest net emission reduction potential is achieved by the residual waste/WDF, followed by paper and biowaste that have high methane emissions if landfilled.
- While this Projection 2 does not consider contingency capacities for landfilling or other wastes requiring landfilling, a small amount still is allocated to landfilling in each of the material waste streams. A complete discontinuity of landfilling is not realistic.

Total Waste Volume by Material Waste Stream and Residual Waste/WDF in 2035 (Projection 2) in Mt
(% in total, 504 Mt)

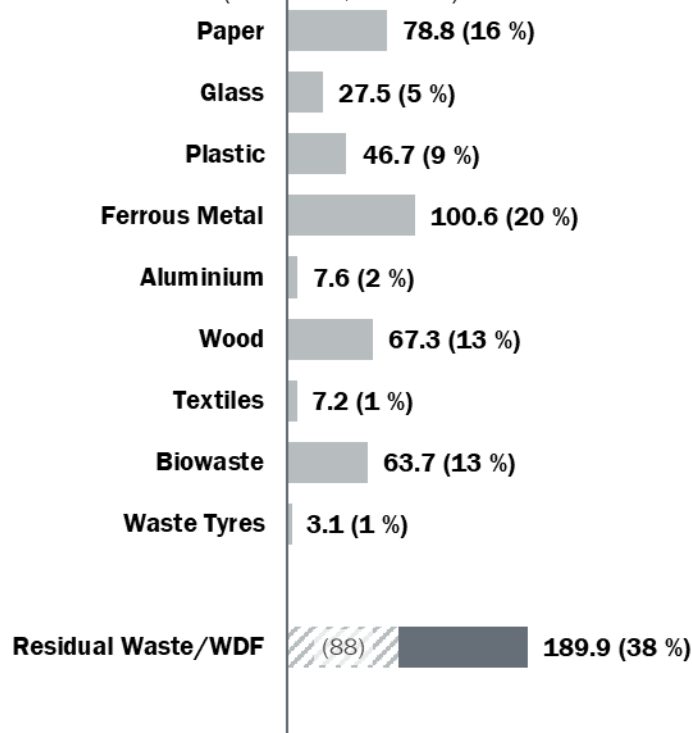

Total Net CO_{2eq} Emissions by Material Waste Stream and Residual Waste/WDF in 2035 (Projection 2)
in Mt CO_{2eq}

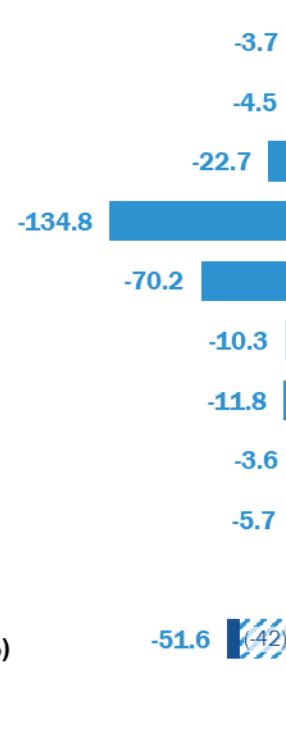

■ Material waste streams ■ Other waste streams /// Overlap with material waste streams

Projection 2 does not consider contingency capacities for landfilling or other wastes requiring landfilling. Treatment unknown not included in Baseline CO₂ estimation. In projections assumed to be treated as in EU. 20-year time horizon for greenhouse gas effects in the atmosphere, excl. transport.

*** Overlap: Sorting and recycling losses, and non-recycled municipal waste feature in the material waste streams and residual wastes/WDF (waste derived fuels and residual waste) and are marked up as the overlap. The total 504 Mt exclude the double counting. Percentages thus add up to >100%. The overlap for net CO_{2eq} emissions are comprised of positive and negative values.

Sources: Eurostat, ETRMA, various sources of bibliography; assessment and calculation by Prognos and CE Delft

Combined totals of material waste streams and residual wastes/WDF

Waste material and CO₂ reduction potential to protect the climate

- From 505 Mt waste across the 10 selected waste streams, 402.5 Mt are comprised by the material specific waste streams. In terms of weight, these are dominated by ferrous metal (25% from 402 Mt), paper and cardboard (20%), and wood (17%).
 - The residual wastes/WDF (waste derived fuels and residual waste) in the Baseline, 237 Mt., partially overlap with the material waste streams (sorting and recycling losses, municipal residual waste), by about ~135 Mt. The largest part of this is the municipal residual waste (non-recycled municipal waste) and sorting residues (W103). With increased recycling, the remaining amount for landfill and Energy Recovery/other thermal treatment decreases. This decrease is larger than the increase from more sorting and recycling losses from more recycling. The residual wastes/WDF decline to 190 Mt in Projection 2. The interactions of marginally lower losses and higher recycling targets reduce the relative overlap to increase the total waste volume to 504 Mt in Projection 2. Considering the material waste streams and residual wastes/WDF, an increase in the recycling rate from 39% (201 Mt) to 59% (296 Mt) is estimated and a decrease in landfill from 26% (133 Mt) to below 1% (<3 Mt) in Projection 2. Residual wastes include sorting residues (W103) (see Annex EWC Codes). This lowers in the overall results the recycling rate.
 - The resulting effect on the CO₂ burden is estimated to fall from a burden of 13 Mt CO_{2eq} in the Baseline scenario (excl. unknown treatment) to the net avoidance of:
 - 137 Mt CO_{2eq} in Projection 1 (incl. unknown treatment)
 - 283 Mt CO_{2eq} in Projection 2 (incl. unknown treatment)
 - Paper & cardboard (76 Mt CO_{2eq}) and biowaste (37 Mt CO_{2eq}) have a net GHG burden in the Baseline scenario. Next to residual wastes/WDF, these material waste streams show the largest net CO₂ emission savings in the implementation of Projection 1 and 2. Although textiles show a near net zero CO_{2eq} burden in the Baseline, these figures do not include the gap from the waste treatment routes which are unknown (0.6 Mt). Their inclusion is likely to render its net emissions to clear burdens in the Baseline. The burden for plastics including the unknown treatment of 7.8 Mt is also likely to be significantly higher in the Baseline than indicated.
 - Ferrous metal (-121 Mt CO_{2eq}) and aluminium (-59 Mt CO_{2eq}) have the largest net savings (i.e. net avoidance) in all three scenarios.
- Primary drivers of the CO₂ reduction:**
 - Reduction of biogenic materials allocated to landfill is the principal driver for the significant CO₂ reduction potential, especially in the waste streams paper & cardboard and biowaste, but also in residual wastes/WDF.
 - Additional large reductions result from decreased residual waste volumes and improvements in the CO₂ factors of co-incineration by avoided emissions from coal in Projection 2.
 - 20 vs 100-year time horizon**
 - Contrasted against a 100-year time horizon, the GHG-emissions in the 20-year Baseline are higher, are more imminent:
 - Baseline: 13 vs -122 Mt CO_{2eq}
 - Projection 1: -137 vs -194 Mt CO_{2eq}
 - Projection 2: -283 vs -250 Mt CO_{2eq}
 - The difference is driven by landfilling of especially the organic materials which factor much higher in the 20-year time horizon and cannot compensate the also larger avoidance from recycling and Energy Recovery/other thermal treatment.
 - The resulting differences are more moderate in Projection 1. In Projection 2, the net savings of the 20-year perspective are greater, as the avoidance is also more immediate.
 - 20-year time horizon **vs the 20-year time horizon marginal approach** shows a more pronounced difference, given the emission avoidance from considering only conventional fossil-based electricity and heat generation:
 - Baseline: 13 vs -60 Mt CO_{2eq}
 - Projection 1: -137 vs -206 Mt CO_{2eq}
 - Projection 2: -283 vs -395 Mt CO_{2eq}
 - The exclusion of the **derogation option** does not have a noteworthy effect on the overall emissions (scenario 1: -4 Mt CO_{2eq}) from less landfilling (-2 Mt, less than in the standard option), as the respective countries have relatively small waste streams and apply to only few waste sources. The derogation option, however, may be for individual countries important for them to adjust, while it has a negligible estimated potential effect on the overall results at the European level.

Main Results per Material Waste Stream (excluding residual waste/WDF)

05



Total Material Waste Streams*

Source © Fotolia - giannip

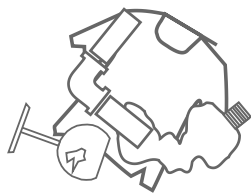

402 Mt

Key results

Material waste streams' volume*

402 Mt of estimated waste generated and statistically recorded within the EU 27+UK in 2018. Corresponding to an average of 784 kg per inhabitant. In weight, ferrous metal (101 Mt), paper (79 Mt) and wood (67 Mt) constitute the largest amongst the 9 selected material waste streams.

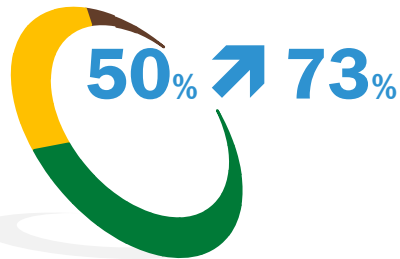

Material recycling

In 2018, approx. 50% (201 Mt) were recycled and 28% (114 Mt) were energy recovered/otherwise thermally treated**. In the projections, the total material recycling rate was estimated to achieve ~73% by 2035, corresponding to approx. 295 Mt. By decreasing the allocated amount to landfilling, in the more ambitious Projection 2, approx. 104 Mt will be energy recovered/otherwise thermally treated.

CO₂ emission savings



While in 2018 the net CO₂ emission burden amounted to -96 Mt CO_{2eq}, in Projection 1 it falls to -235 Mt CO_{2eq} in 2035. This is primarily the result of a lowered allocation to landfilling. By further avoiding landfilling of waste, net emissions of approx. -267 Mt CO_{2eq} are achieved by 2035 in Projection 2. -6 Mt CO_{2eq} of additional potential exists in treating currently unknown treated plastic and textiles wastes in the EU as in Projection 2.

*for the allocated EWC-Codes please refer to Annex EWC-Codes

**at point of measurement after sorting
(tyres) i.e. except residual waste/WDF

*material waste streams, i.e. all material streams considered in this study (paper & cardboard, glass, plastic, ferrous metal, aluminium, wood, textiles, biowaste,

Material waste stream totals

 **402**
Mt/2018

 **784**
kg/ihh (2018)

Key results

- An increase in recycling rate from 50% (201 Mt) to 73% (296 Mt) and a decrease in landfill from 20% (79 Mt) to below 1% (<3 Mt) is estimated in Projection 2.
- The resulting net CO₂ emissions fall from -96 Mt to -267 Mt CO_{2eq} by 2035 in Projection 2. -6.4 Mt CO_{2eq} of additional potential exists in treating currently unknown treated plastic and textiles wastes in the EU as in Projection 2.

Sources: Eurostat, ETRMA, various sources of bibliography; assessment and calculation by Prognos and CE Delft

Waste Management Route

■ Recycling (output rate) ■ Energy Recovery/other thermal treatment ■ Landfilling ■ Treatment unknown (all figures in Mt)

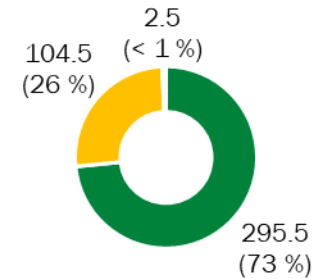
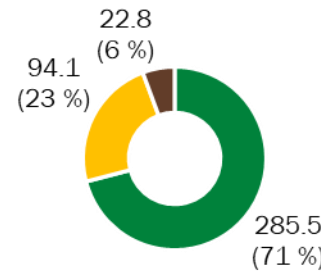
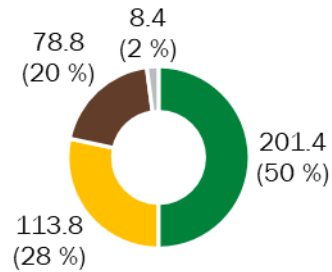

CO_{2eq} Net Emissions

■ Total CO_{2eq} Net Emissions per year ■ CO_{2eq} from unknown treatment (all figures in Mt CO_{2eq})

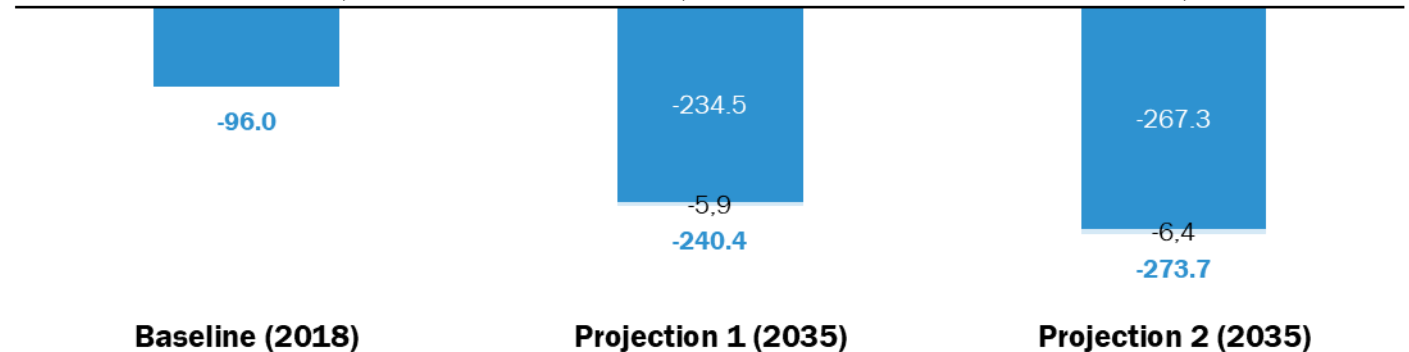

Projection 1 waste targets incl. derogation option. Projection 2 does not consider contingency capacities for landfilling or other wastes requiring landfilling. Treatment unknown not included in Baseline CO₂ estimation. In projections assumed to be treated as in EU, and separately indicated. Recycling figures relate to output rates after sorting losses, in accordance with the legislative point of measurement. 20-year time horizon for greenhouse gas effects in the atmosphere, excl. transport.

Sources: Eurostat, ETRMA, various sources of bibliography; assessment and calculation by Prognos and CE Delft

Material waste stream totals

Waste material and CO₂ reduction potential to protect the climate

- Amongst the material waste streams (402.5 Mt), ferrous metal (25%), paper & cardboard (20%), and wood (17%) are the largest.
- Paper & cardboard (76 Mt CO_{2eq}), biowaste (37 Mt CO_{2eq}), and plastics (1 Mt CO_{2eq}) have a net CO₂ burden.
- Ferrous metal (-121 Mt CO_{2eq}), aluminium (-59 Mt CO_{2eq}) and wood (-23 Mt CO_{2eq}) have net CO₂ savings (i.e. a negative burden) in the baseline.
- Considering the material waste streams, an increase in recycling rate from 50% (201 Mt) to 73% (296 Mt) is estimated along with a decrease in landfill from 20% (79 Mt) to below 1% (<3 Mt) in Projection 2.
- The **CO₂ burden in the Baseline** is estimated at
 - -96 Mt CO_{2eq} (excl. unknown treatment) falls to:
 - -235 Mt CO_{2eq} in Projection 1 (excl. unknown treatment)
 - -267 Mt CO_{2eq} in Projection 2 (excl. unknown treatment)with an additional potential of around -5.9 to -6.4 Mt CO_{2eq} by treating the unknown treated wastes as in the EU Projection 1 and 2.
- The amount allocated to energy recovery/other thermal treatment decreases from the Baseline to Projection 1 (28% to 23%), but increases in Projection 2 to 26% (104 Mt) as previous volumes allocated to landfill are re-allocated to recycling and energy recovery/other thermal treatment.
- **Primary drivers of the CO₂ reduction:**
 - Reduction of organic fractions allocated to landfill are the principal driver of the significant CO₂ reduction, especially in the waste streams paper & cardboard and biowaste.
 - Additional large reductions result from the decreased volumes and improvements in the CO₂ factors of co-incineration by avoided emissions in Projection 2.
 - However, also the increased recycling volume increases avoided emissions.
- **20 vs 100-year time horizon**
 - The 100-year time horizon has a lower net CO₂ emissions than in the 20-year time horizon in the Baseline and in Projection 1:
 - Baseline: -96 vs -171 Mt CO_{2eq}
 - Projection 1: -240 vs -243 Mt CO_{2eq} (incl. unknown treatment)
 - Projection 2: -274 vs -255 Mt CO_{2eq} (incl. unknown treatment)
 - The stark difference is driven by landfilling of especially the organic materials which have a factor that is much higher in the 20-year time horizon and cannot compensate the also larger net avoidance from recycling and energy recovery/other thermal treatment. In Projection 2, this relationship is inverted with more immediate larger avoidance from recycling and energy recovery/other thermal treatment.
- 20-year time horizon **vs the 20-year time horizon marginal approach** is pronounced
 - Baseline: -96 vs -152 Mt CO_{2eq}
 - Projection 1: -240 vs -288 Mt CO_{2eq} (incl. unknown treatment)
 - Projection 2: -274 vs -341 Mt CO_{2eq} (incl. unknown treatment)
- The exclusion of the **derogation option** does not have a noteworthy effect on the totals at the European level. This is also the case for the individual waste streams of the study.
- Transport is not included.



Paper & Cardboard*

Source: © iStock - Lightstar59-min

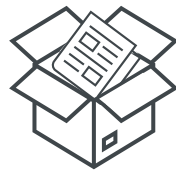

78.8 Mt

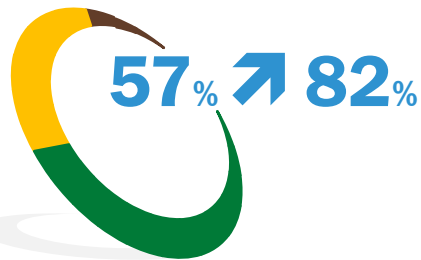

Key results

Paper & Cardboard volume

78.8 Mt of estimated waste paper and cardboard generated and statistically recorded within the EU 27+UK in 2018. Corresponding to an average of 154 kg per inhabitant.

Waste paper is primarily generated by households and industrial sources, but also originates from construction and demolition waste*.

Material recycling

In 2018, approx. 57% (45 Mt) were recycled and 19% (15 Mt) were thermally treated (incl. energy recovery/other thermal treatment)**.

In the projections, the total material recycling rate was estimated to achieve ~82% by 2035, corresponding to approx. 64 Mt. By also decreasing the allocated amount to landfilling, in the more ambitious Projection 2, approx. 14 Mt will be energy recovered.

CO₂ emission savings

While in 2018 the net CO₂ emission burden amounted to 76 Mt CO_{2eq}, in Projection 1 it falls to 18 Mt CO_{2eq} in 2035. This is primarily the result of a lowered allocation to landfilling. By further avoiding landfilling of paper waste, net emissions of approx. -4 Mt CO_{2eq} can be achieved by 2035 in Projection 2.

This presents the largest reduction against the Baseline amongst the selected material waste streams.

*for the allocated EWC-Codes please refer to Annex EWC-Codes
**at point of measurement after sorting

Paper & Cardboard



79
Mt/2018



154
kg/ihn (2018)

Key results

- Paper & cardboard has the largest CO₂ burden amongst the selected waste streams, due to methane emissions from landfilled material.
- Paper has also the largest net CO₂ emission reduction potential (by -79 Mt CO_{2eq}) amongst the selected waste streams.
- Primary drivers of the CO₂ reduction is the reduced allocation to landfill.

Sources: Eurostat, various sources of bibliography; assessment and calculation by Prognos and CE Delft

Waste Management Route

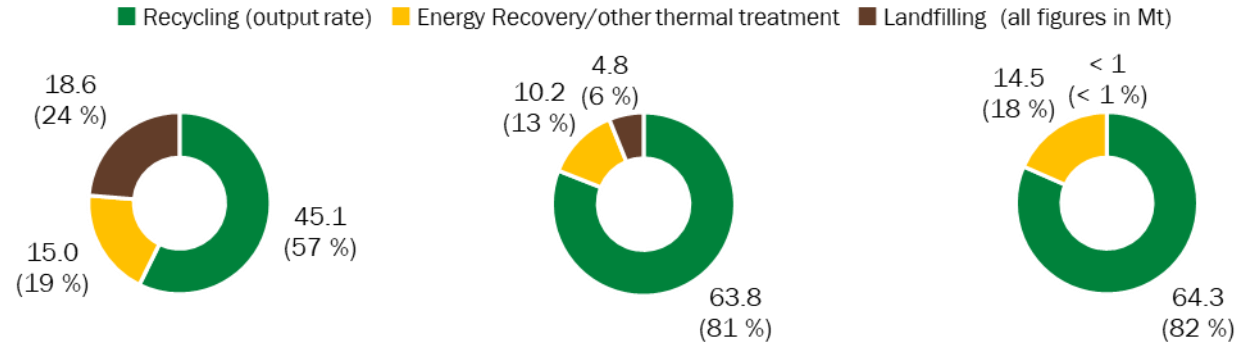

CO_{2eq} Net Emissions

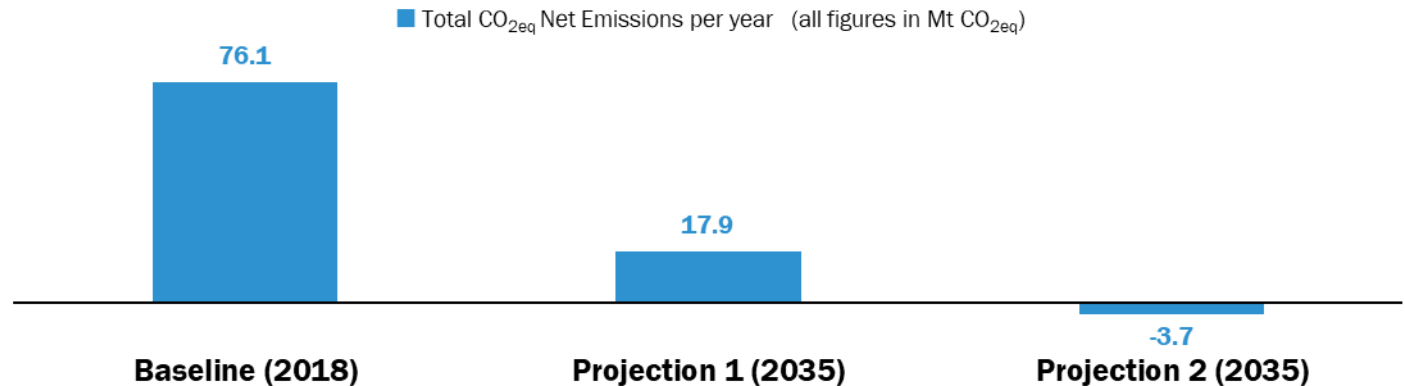

Projection 1 waste targets incl. derogation option. Projection 2 does not consider contingency capacities for landfilling or other wastes requiring landfilling. Recycling figures relate to output rates after sorting losses, in accordance with the legislative point of measurement. 20-year time horizon for greenhouse gas effects in the atmosphere, excl. transport.

Paper & Cardboard

Waste material and CO₂ reduction potential to protect the climate

- Paper & cardboard has the largest CO₂ burden amongst the selected waste streams (76 Mt CO_{2eq}).
- An increase in recycling rate from 57% (45 Mt) to 82% (64 Mt) is estimated and a decrease in landfill from 24% (19 Mt) to:
 - 6% (5 Mt) in Projection 1
 - <1% (<0.1 Mt) in Projection 2
- The amount energy recovered/otherwise thermally treated remains relatively stable, first decreasing from 15 to 10 Mt then increasing in Projection 2 to 14.5 Mt. This is a result of the re-allocation of landfill to recycling and thermal treatment.
- The CO₂ burden in the Baseline is estimated at
 - 76 Mt CO_{2eq}, and falls to:
 - 18 Mt CO_{2eq} in Projection 1
 - -4 Mt CO_{2eq} in Projection 2

This presents the largest potentially additional net CO₂ saving (~80 Mt CO_{2eq}) amongst the selected waste streams.

- **Primary drivers of the CO₂ reduction:**
 - Reduced allocation to landfill reduces the CO₂ burden by up to 83 Mt CO_{2eq}.
 - However, the increased amount allocated to recycling increases the CO₂ burden by ~3 Mt CO_{2eq} resulting in a reduction by 80 Mt CO_{2eq} compared to the Baseline
 - Although energy recovery/other thermal treatment has a more beneficial net CO_{2eq} emission, the waste hierarchy emphasizes recycling as a priority treatment route.

- **20 vs 100-year time horizon**, the difference is markable:
 - Baseline: 76 vs 20 Mt CO_{2eq}
 - Projection 1: 18 vs 2 Mt CO_{2eq}
 - Projection 2: -4 vs -5 Mt CO_{2eq}
 - Landfilling of paper & cardboard has the highest CO₂ factor, which when reducing the time horizon for the global warming effects in the atmosphere are significantly larger in the 20-year time horizon than in the 100-year. This amplifies the 20-year time horizon's CO₂ burden.
- **20-year time horizon vs the 20-year time horizon marginal approach:** The marginal approach has a smaller net CO₂ result, as the energy recovery/other thermal treatment in Baseline, Projection 1 and 2 have a lower (more negative) CO₂ result:
 - Baseline: 76 vs 68 Mt CO_{2eq}
 - Projection 1: 18 vs 13 Mt CO_{2eq}
 - Projection 2: -4 vs -14 Mt CO_{2eq}
- The derogation option for the implementation of the municipal waste related targets does not have a noteworthy effect at the European level.



Glass*

Source: © AdobeStock - Goodpics-min

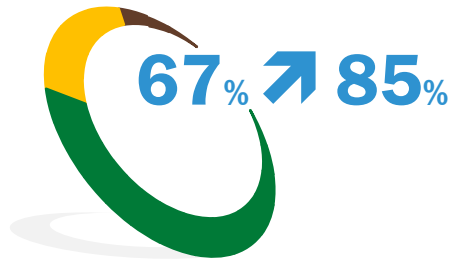

Key results

Glass volume

27.5 Mt of estimated glass waste generated and statistically recorded within the EU 27+UK in 2018. Corresponding to an average of 54 kg per inhabitant. Glass waste is primarily generated by households and industrial sources, but also originates from construction and demolition waste and end-of-life vehicles.

Material recycling

Glass is already recycled to a large extent (67%, 18 Mt) in 2018, while approx. 15% (4 Mt) are estimated to be energy recovered/otherwise thermally treated**.

In the projections, the total material recycling rate was estimated to achieve ~84% by 2035 in Projection 1 and 85% in the more ambitious Projection 2, corresponding to approx. 23 Mt.

CO₂ emission savings

Treatment of glass already has a negative CO₂ result (-4 Mt CO_{2eq}) and decreases in the projections further to approx. -5 Mt CO_{2eq} by 2035.

*for the allocated EWC-Codes please refer to Annex EWC-Codes
**at point of measurement after sorting

Glass



28

Mt/2018



54

kg/ihn (2018)

Waste Management Route

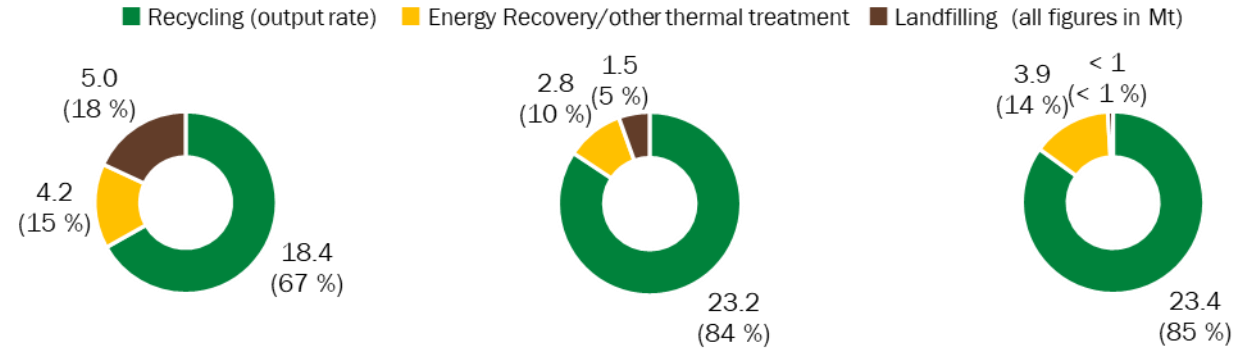

CO_{2eq} Net Emissions

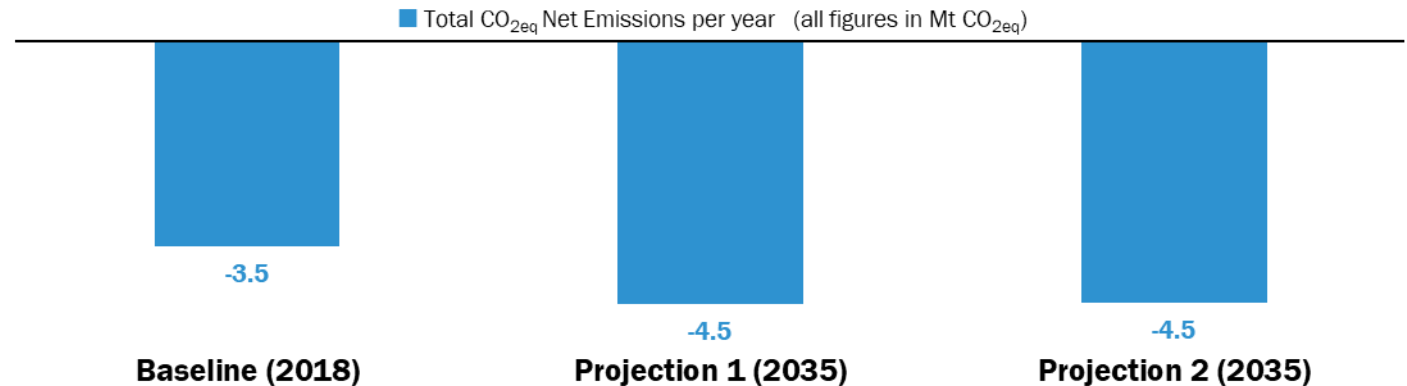

Key results

- Glass already has after ferrous metal and aluminium the highest recycling rate in the Baseline scenario.
- Glass has little additional net CO₂ saving potentials compared to other material waste streams.

Projection 1 waste targets incl. derogation option. Projection 2 does not consider contingency capacities for landfilling or other wastes requiring landfilling. Recycling figures relate to output rates after sorting losses, in accordance with the legislative point of measurement. 20-year time horizon for greenhouse gas effects in the atmosphere, excl. transport.

Sources: Eurostat, various sources of bibliography; assessment and calculation by Prognos and CE Delft

Waste material and CO₂ reduction potential to protect the climate

- Glass already has after ferrous metal and aluminium the highest recycling rate in the Baseline
- An increase in recycling rate from 67% (18 Mt) to 85% (23 Mt) is estimated and a decrease in landfill from 18% (5 Mt) to:
 - 5% (1.5 Mt), in Projection 1
 - <1% (0.3 Mt) in Projection 2
- The net CO₂ result in the Baseline is estimated at
 - -3.5 Mt CO_{2eq}, falls to:
 - -4.5 Mt CO_{2eq}, in Projection 1
 - -4.5 Mt CO_{2eq}, in Projection 2
- **Primary drivers of the CO₂ reduction:**
 - The increase in recycling reduces the CO₂ emissions by -1 Mt CO₂ more than the reduced allocation to landfill by 3.6-4.7 Mt of waste.
- **20 vs 100-year time horizon**, has little effect
 - Baseline: -3.5 Mt vs -3.2 Mt CO_{2eq}
 - Projection 1: -4.5 Mt vs -4.1 Mt CO_{2eq}
 - Projection 2: -4.5 Mt vs -4.0 Mt CO_{2eq}
- Glass' CO₂ saving is primarily driven by recycling.
- The **marginal approach** and the **derogation option** for the implementation of the municipal waste related targets have barely any effect on the CO₂ emissions in the 20-years time horizon perspective at the European level.



Plastics*

Source: © AdobeStock - Dmytro Panchenko-min

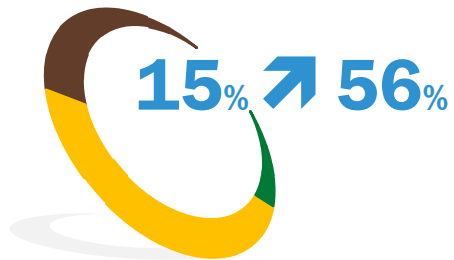
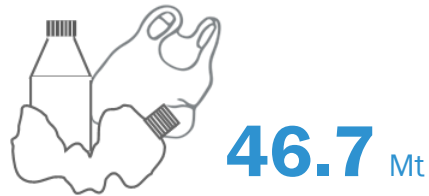

Key results

Plastics' volume

46.7 Mt of estimated plastic waste generated and statistically recorded within the EU 27+UK in 2018 incl. 7.8 Mt of unknown treated plastic waste. This corresponds to an average of 91 kg per inhabitant. Plastic waste is primarily generated by households and industrial sources, but also originates from construction and demolition waste and end-of-life vehicles*.

Material recycling

In 2018, approx. 15% (7 Mt) were recycled and 39% (18 Mt) were energy recovered/otherwise thermally treated**. In the projections, the total material recycling rate potential was estimated to achieve ~56% by 2035, corresponding to approx. 26 Mt incl. the additional potential from the currently unknown treated plastic waste (7.8 Mt) .

CO₂ emission savings

While in 2018 the net CO₂ emission burden amounted to 1 Mt CO_{2eq}, in Projection 1 it falls to -19 Mt CO_{2eq} in 2035. This is primarily the result of an increase in recycling. Projection 2 achieves a net saving of -23 Mt CO_{2eq} -5 Mt CO_{2eq} additional potential exists in treating currently unknown treated plastic wastes in the EU as in Projection 2.

*for the allocated EWC-Codes please refer to Annex EWC-Codes
**at point of measurement after sorting

Plastics



47
Mt/2018



91
kg/ihn (2018)

Key results

- Next to Textiles, plastic has the lowest recycling rate and has a marginally positive burden (1 Mt CO_{2eq}).
- With an increase in recycling along with less landfilling, although only with a comparably low net CO₂ burden, and changed CO_{2eq} factors (especially co-incineration) in Projection 2, the emissions reach a net avoidance potential of 28 CO_{2eq} Mt.
- Surrounding plastics much uncertainty exists. Increasing recycling to 55% is considered highly ambitious. Also Plastics have a large waste amount, which is not known how it is currently treated, estimated at 7.8 Mt. As the precise treatment route is not known, it is not included in the Baseline net CO_{2eq} figure. Uncertainty exists also around the amount used in co-incineration plants, which has a large effect on the net CO_{2eq} result.

Waste Management Route

■ Recycling (output rate) ■ Energy Recovery/other thermal treatment ■ Landfilling ■ Treatment unknown (all figures in Mt)

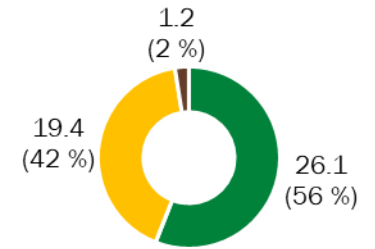
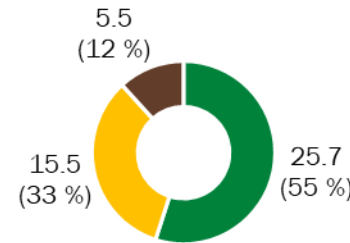
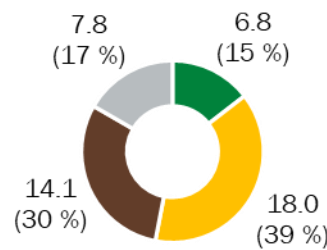

CO_{2eq} Net Emissions

■ Total CO_{2eq} Net Emissions per year ■ CO_{2eq} from unknown treatment (all figures in Mt CO_{2eq})

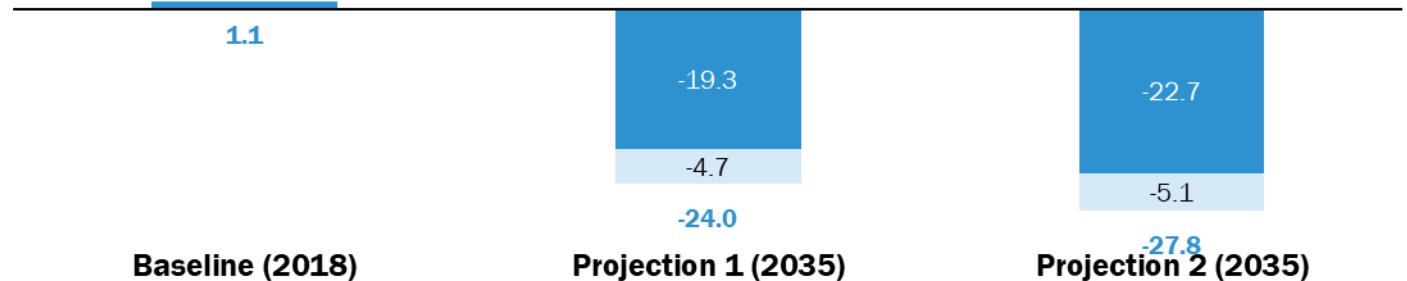

Projection 1 waste targets incl. derogation option. Projection 2 does not consider contingency capacities for landfilling or other wastes requiring landfilling. Treatment unknown not included in Baseline CO₂ estimation. In projections assumed to be treated as in EU, and separately indicated. Recycling figures relate to output rates after sorting losses, in accordance with the legislative point of measurement. 20-year time horizon for greenhouse gas effects in the atmosphere, excl. transport.

Sources: Eurostat, various sources of bibliography; assessment and calculation by Prognos and CE Delft

Waste material and CO₂ reduction potential to protect the climate

- Next to textiles, plastic has the lowest recycling rate. With an increase in recycling along with less landfilling, although only with a comparably low net CO₂ burden, and changed CO_{2eq} factors (especially co-incineration) in Projection 2, the emissions reach a net avoidance potential of -28 CO_{2eq} Mt.
- Surrounding plastics much uncertainty exists. Plastics have a large waste amount, which is not known how it is currently treated, estimated at 7.8 Mt. As the precise treatment route is not known, it is not included in the Baseline net CO_{2eq} figure, which is expected to be significantly higher than 1Mt CO_{2eq} when included. Uncertainty exists also around the amount used in co-incineration plants, which has a large effect on the net CO_{2eq} result.
- An increase in recycling rate from 15% (7 Mt) to 56% (26 Mt) is estimated under the more ambitious Projection 2 and results in a decrease in landfill from 30% (14 Mt) to:
 - 12% (5.5 Mt), in Projection 1
 - 2% (1.2 Mt) in Projection 2
- An increase in recycling to 55%, considered in Projection 1, constitutes a highly ambitious target.
- The net CO₂ result in the Baseline is estimated at
 - 1 Mt CO_{2eq}, (excl. unknown treatment) and falls to:
 - -19 Mt CO_{2eq} in Projection 1 (excl. unknown treatment)
 - -23 Mt CO_{2eq} in Projection 2 (excl. unknown treatment)
- With the inclusion of the unknown treated amount in the Baseline, the net CO₂ emission is likely to be an overall CO_{2eq} burden in the Baseline.
- When including the Unknown Treatment of 7.8 Mt in the Projections, as if treated in the EU27+UK, the following CO₂ avoidance potential is estimated:
 - -24 Mt CO_{2eq} in Projection 1
 - -28 Mt CO_{2eq} in Projection 2
- **Primary drivers of the CO₂ reduction:**
 - The increase in recycling with a negative CO₂ factor drives the decrease in net CO₂ emissions.
 - In Projection 2 the largest gain is made by the increased amount allocated to recycling, while the CO₂ factor for recycling is also assumed to improve.
- **20 vs 100-year time horizon** has a notable effect:
 - Baseline: 1 Mt vs 5 Mt CO_{2eq}
 - Projection 1: -24 Mt vs -12 Mt CO_{2eq} (incl. unknown treatment)
 - Projection 2: -28 Mt vs -14 Mt CO_{2eq} (incl. unknown treatment)Recycling has a lower saving in the 100-year time horizon, while energy recovery/ other thermal treatment has a larger burden and landfilling a smaller burden. Thus, in the 100-year time horizon the burden is less negative (i.e. lower net avoidance)
 - Energy recovery/other thermal treatment has a marginally larger net burden, due to a marginally lower impact of avoided conventional gas and electricity in a 100-year time horizon. Respectively, co-incineration is significantly lower, due to the substitution of coal, which has a lower burden over the long timespan.
- **20-year time horizon vs the 20-year time horizon marginal approach** reduces the burden of thermal treatment, so that in result the avoidance increases
 - Baseline: 1 Mt vs -13 Mt CO_{2eq}
 - Projection 1: -24 Mt vs -36 Mt CO_{2eq} (incl. unknown treatment)
 - Projection 2: -28 Mt vs -50 Mt CO_{2eq} (incl. unknown treatment)
- The **derogation option** for the implementation of the municipal waste related targets has no noteworthy effect at the European level.

Landfill sensitivity

- More recent EU policies on plastics to tackle plastic pollution and marine litter, and the accelerated transition to a circular plastics economy have contributed to an increased attention on plastic wastes. Data uncertainties are, however, particularly pronounced for plastic wastes. In addition to the unknown treatment path of a sizable amount of plastic waste, presumed to be exported to outside of the EU and UK, an uncertainty was identified regarding the emissions from plastics sent to landfilling
- Depending on the type of plastic, the Ecoinvent datasets for landfilling of plastics include a methane emission of 2 to 3 grams per kg of plastic. The Ecoinvent background data suggests that this emission is due to an estimated 1% of degradability of (fossil carbon within) plastics on landfills. Although the calculated amount of released methane is small, this has a significant effect on the $\text{CO}_{2\text{eq}}$ factor for landfilling of plastics.
- In contrast, the IPCC assumes plastics on landfill to be inert (IPCC 2019; chapter 3).
- Both sources lack further specifications on the underlying assumptions. Both do not include any degradable organic carbon, which could have been a source for the difference (IPCC 2019; chapter 2). It is outside the scope of this study to resolve this inconsistency.
- To provide a quantitative orientation on the difference, a sensitivity assessment was carried out for the case in which the methane emissions from plastics in landfill are zero.

Sensitivity assessment results

- If no methane emission is assumed for plastics, the baseline result changes from 1.1 Mt to -2.4 Mt $\text{CO}_{2\text{eq}}$ i.e. including avoidances and burdens from recycling and energy recovery/other thermal treatment. The choice on the $\text{CO}_{2\text{eq}}$ factor for landfilling of plastic wastes has, thus, in this case, a sizable (3.5 Mt $\text{CO}_{2\text{eq}}$) impact on the overall $\text{CO}_{2\text{eq}}$ emission balance of plastic waste treatment in Europe. It underscores the importance of additional and transparent research in this field. With increasing attention on plastic and its disposal and treatment, both from EU policies and the public, this topic deserves further investigation.
- In our study we have not taken into account any biobased biodegradable plastics. If, in the future, the share of biodegradable plastics will increase, this will increase methane emissions from landfilled plastics.

Chemical recycling of plastics and processing plastic into fuel

Technical background

- Future potentials provided by chemical recycling of plastics were **not considered in the projections**, due to it being a diverse field and an emerging technology, and in-depth LCA studies are mostly confidential and not publicly available.
- Chemical recycling of plastics is a **rapidly developing field**. For many plastic types, chemical recycling techniques are either at advanced levels of technology readiness (pilot scale plants) or fully operational and market ready.
- Four types of chemical recycling techniques are typically distinguished: solvent-based extraction, depolymerisation, pyrolysis, and gasification. Not all technologies are applicable to all plastic types – a specific depolymerisation process may only work for PET input, for instance. In addition, the technologies yield different types of products such as monomers, basic chemicals or other mixtures that can be used as feedstock. In general, chemical recycling is seen as a promising addition to mechanical recycling, since it may be able to process waste fractions that are less suited for mechanical recycling such as contaminated streams or mixed plastic streams (e.g. depolymerisation of PET trays incl. PE, or pyrolysis of mixed polyolefins such as PE, PP). Finally, chemical recycling can enable the ‘upcycling’ of post-consumer plastic products into new virgin-quality plastics that can be used in different applications, for instance taking textile polyester such as fleece to produce food-grade recycled PET.

Impact on CO₂ emissions

There are two main environmental aspects:

- **Energy consumption:**

Chemical recycling processes are often energy-intensive and may require pre-treatment steps and/or further downstream treatment of the products, in order to substitute basic chemicals or raw feedstock. Whether a chemical recycling process leads to a net CO₂ benefit (i.e., more avoided emissions than emissions from the recycling processes) mainly depends on the energy efficiency and/or the use of renewable energy sources for the recycling processes.

- **Processing plastics into fuels:**

Some chemical processes can be used to produce fuels from waste plastics, which is an energy recovery operation. If waste plastics are converted into fuels, which are later combusted, the carbon in the plastics is emitted as CO₂. While this could still be beneficial from an environmental point of view, preventing the use of fossil diesel for example, the carbon is lost from the economy and cannot be re-used to produce new plastics. If waste plastics are continuously recycled into new plastics instead, the same carbon remains fixed and is not emitted. Currently unclear is whether the production of fuels for plastics will have any environmental benefit over processing plastics in waste-to-energy or co-incineration plants.

Due to the complexities and current uncertainties of the processes, chemical recycling has not been included in the scope of this study.

Source: [CE Delft 2019]



Ferrous Metal*

Source: © iStock - clu-min

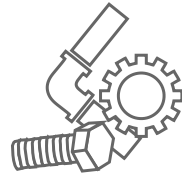

101 Mt

Key results

Ferrous metal volume

101 Mt of estimated ferrous metal waste generated and statistically recorded within the EU 27+UK in 2018. Corresponding to an average of 196 kg per inhabitant. Ferrous metal waste is primarily generated by households and industrial sources, but also originates from construction and demolition waste*.

Material recycling

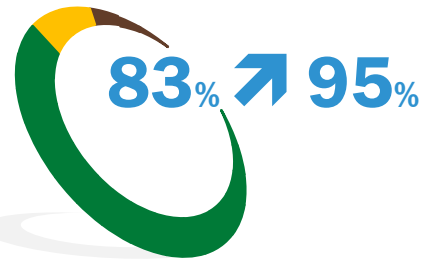

In 2018, approx. 83% (83 Mt) were recycled and 7% (7 Mt) were energy recovered/otherwise thermally treated**.

In the projections, the total material recycling rate was estimated to achieve ~95% by 2035, corresponding to approx. 95 Mt. By decreasing the allocated amount to landfilling, in the more ambitious Projection 2, approx. 5 Mt are energy recovered.

CO₂ emission savings

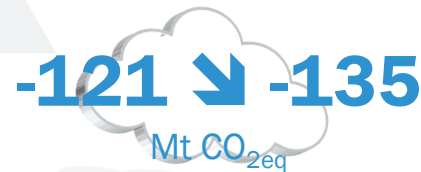

While in 2018 the net CO₂ emission savings amounted to -121 Mt CO_{2eq}, in Projection 1 it falls to -132 Mt CO_{2eq} in 2035. For Projection 2 a potential of -135 Mt CO_{2eq} is estimated.

Ferrous metal wastes, due to the avoided emissions from recycling, has the largest savings contribution amongst the selected waste streams, but relatively little additional potential gains.

*for the allocated EWC-Codes please refer to Annex EWC-Codes
**at point of measurement after sorting

Ferrous metal



101
Mt/2018



196
kg/ihn (2018)

Waste Management Route

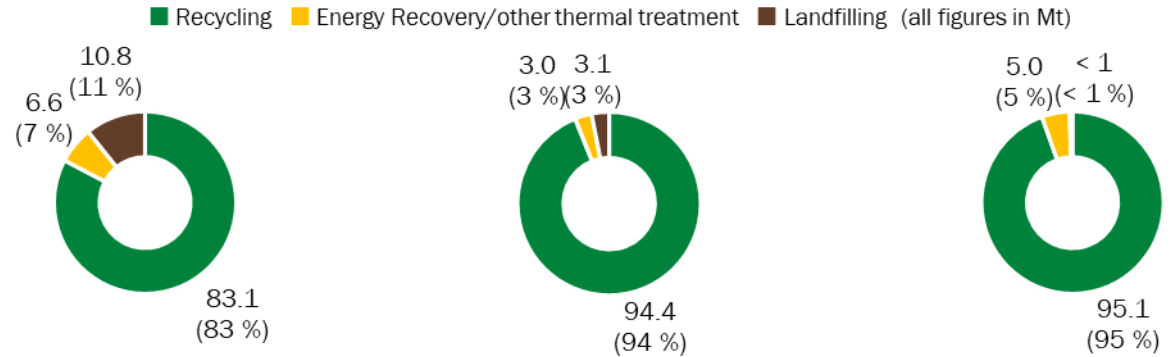

CO_{2eq} Net Emissions

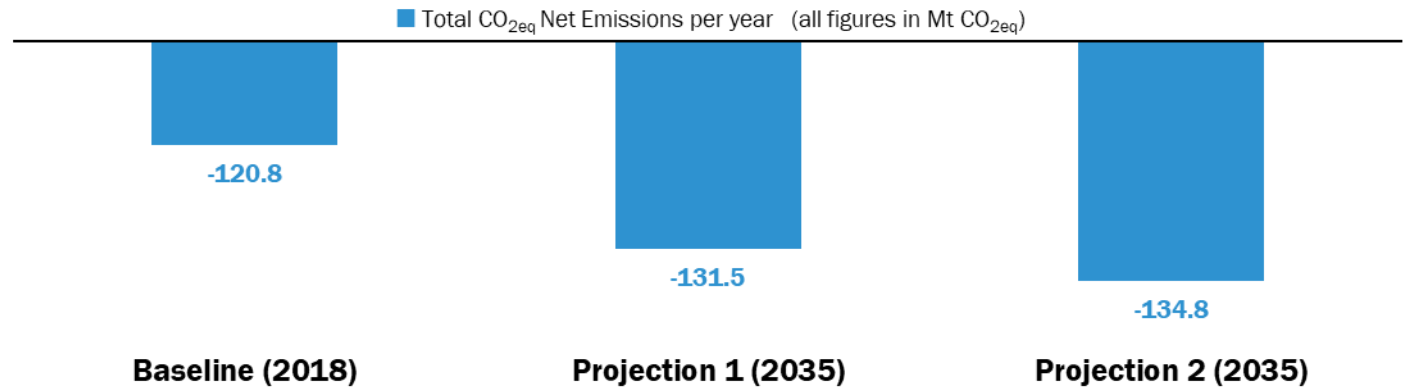

Key results

- Ferrous metal has the highest recycling rate amongst the selected waste streams and the largest net CO₂ avoidance.
- By avoiding the production of primary ferrous metal, recycling provides for large net CO₂ savings: -121 Mt.

Projection 1 waste targets incl. derogation option. Projection 2 does not consider contingency capacities for landfilling or other wastes requiring landfilling. Recycling figures relate to output rates after sorting losses, in accordance with the legislative point of measurement. 20-year time horizon for greenhouse gas effects in the atmosphere, excl. transport.

Sources: Eurostat, various sources of bibliography; assessment and calculation by Prognos and CE Delft

Ferrous metal

Waste material and CO₂ reduction potential to protect the climate

- Ferrous metal has the highest recycling rate amongst the selected waste streams and the largest net CO₂ savings.
 - An increase in recycling rate from 83% (83 Mt) to 95% (95 Mt) is projected and a decrease in landfill from 11% (11 Mt) to:
 - 3% (3 Mt) in Projection 1
 - 1% (0.5 Mt) in Projection 2
 - The CO₂ burden in the Baseline is estimated at
 - -121 Mt CO_{2eq} and falls to:
 - -132 Mt CO_{2eq} in Projection 1
 - -135 Mt CO_{2eq} in Projection 2
- By avoiding the production of primary ferrous metal, recycling provides for very large net CO₂ savings of 121 Mt.
- Primary drivers of the CO₂ reduction:
 - The increased amount allocated to recycling has a larger CO₂ avoidance impact than the reduction of energy recovery/other thermal treatment.
 - Landfill has a relatively neutral factor of 6kg CO_{2eq} per tonne compared to -1,352 kg CO_{2eq} per tonne for recycling.
 - Ferrous metals that end up in waste-to-energy plants are largely recovered from the bottom ashes and recycled.

- **Whether choosing a 20 or a 100-year time horizon**, has only a small effect (<0,1 Mt CO_{2eq}).
- The **marginal approach** and **derogation option** for the implementation of the municipal waste related targets have no noteworthy effect at the European level.

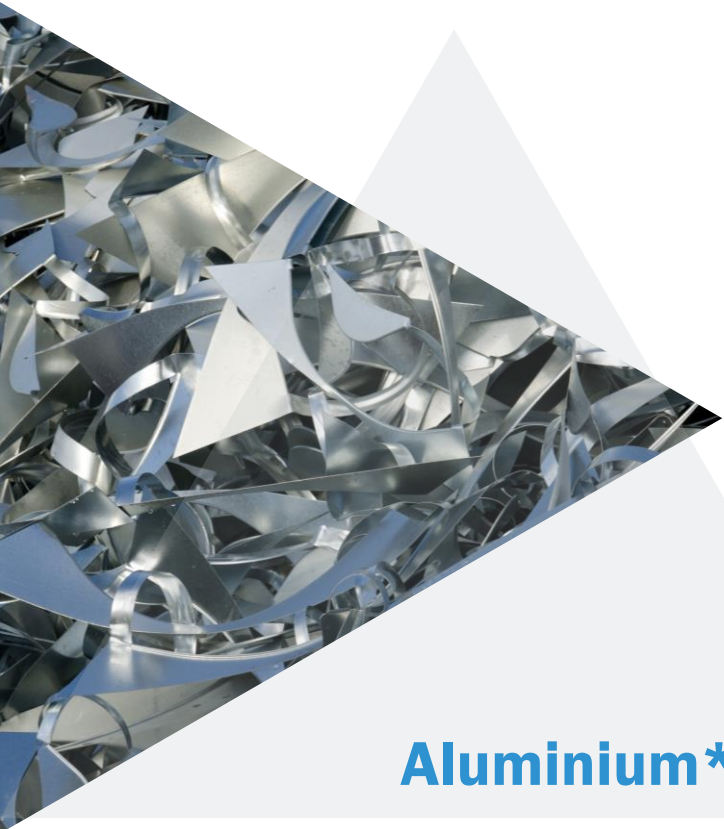

Aluminium*

Source: © Fotolia - Petair_56328055_XL



7.6 Mt

Key results

Aluminium volume

8 Mt of estimated aluminium waste generated and statistically recorded within the EU 27+UK in 2018. Corresponding to an average of 15 kg per inhabitant. Aluminium waste is primarily generated by households and industrial sources, but also originates from construction and demolition waste.

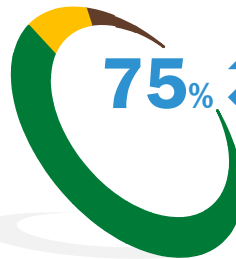

75% **↗** **92%**

Material recycling

In 2018, approx. 75% (6 Mt) were recycled and 9% (1 Mt) were energy recovered/otherwise thermally treated**. In the projections, the total material recycling rate was estimated to achieve ~92% by 2035, corresponding to approx. 7 Mt. By decreasing the allocated amount to landfilling, in the more ambitious Projection 2, a potential of approx. 0.5 Mt could be energy recovered/otherwise thermally treated.

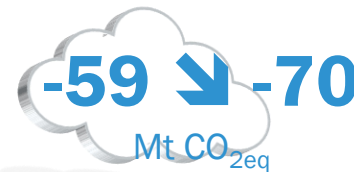

-59 **↘** **-70**
Mt CO_{2eq}

CO₂ emission savings

While in 2018 the net CO₂ emission savings amounted -59 Mt CO_{2eq}, in Projection 1 it falls to -68 Mt CO_{2eq} in 2035. This is primarily the result of increasing the recycling amount. By further avoiding landfilling, a net avoidance of -70 Mt CO_{2eq} is achieved in Projection 2. Aluminium recycling has the largest net CO₂ avoidance per tonne of waste.

*for the allocated EWC-Codes please refer to Annex EWC-Codes
**at point of measurement after sorting

Aluminium



8

Mt/2018



15

kg/ihn (2018)

Waste Management Route

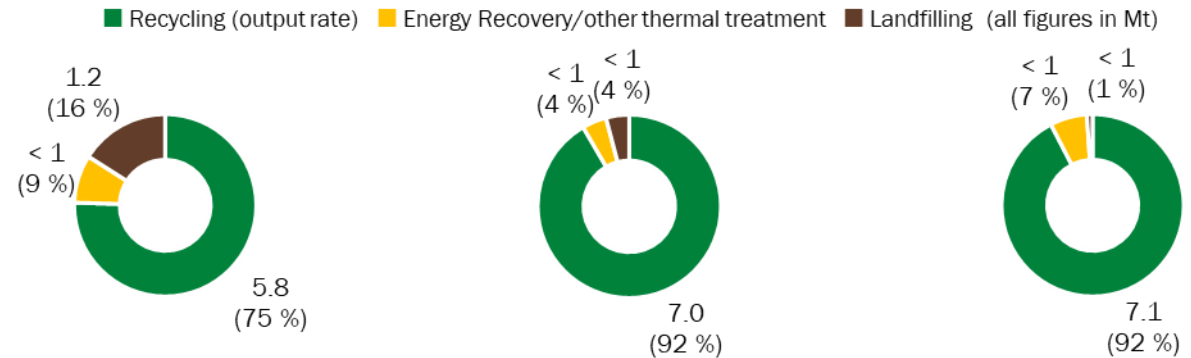

CO_{2eq} Net Emissions

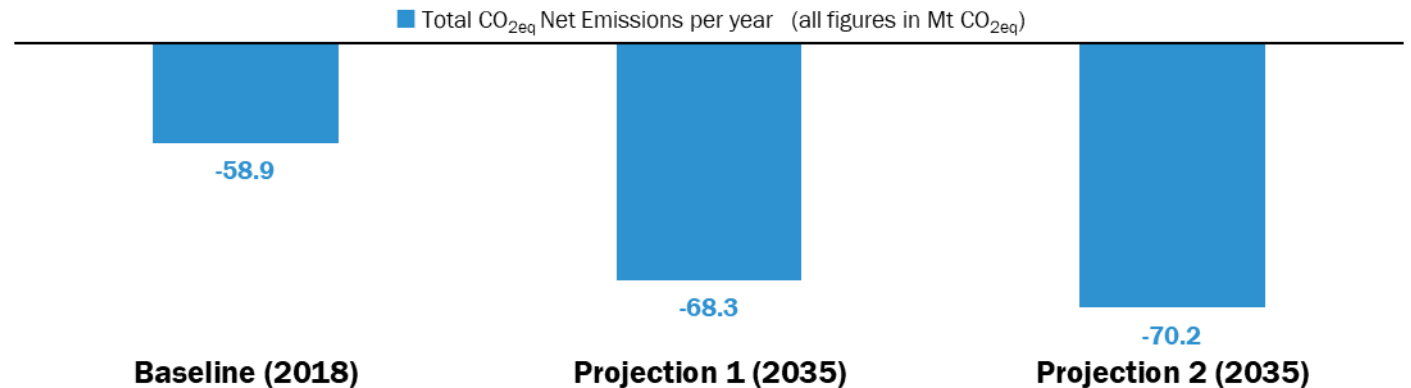

Key results

- Aluminium has the second highest recycling rate and second largest net CO₂ avoidance amongst the selected waste streams.
- By avoiding the production of primary aluminium, recycling provides a large net CO₂ avoidance.
- Aluminium recycling has the largest net CO₂ avoidance per tonnage of waste.

Projection 1 waste targets incl. derogation option. Projection 2 does not consider contingency capacities for landfilling or other wastes requiring landfilling. Recycling figures relate to output rates after sorting losses, in accordance with the legislative point of measurement. 20-year time horizon for greenhouse gas effects in the atmosphere, excl. transport.

Sources: Eurostat, various sources of bibliography; assessment and calculation by Prognos and CE Delft

Waste material and CO₂ reduction potential to protect the climate

- Aluminium has the second highest recycling rate and second largest net CO₂ avoidance amongst the selected waste streams.
- An increase in the recycling rate from 75% (6 Mt) to 92% (7 Mt) is estimated and a decrease in landfill from 16% (1 Mt) to:
 - 4% (0.3 Mt) in Projection 1
 - 1% (0.1 Mt) in Projection 2
- The CO₂ burden in the Baseline is estimated at
 - -59 Mt CO_{2eq} and falls to:
 - -68 Mt CO_{2eq} in Projection 1
 - -70 Mt CO_{2eq} in Projection 2
- **Primary drivers of the CO₂ reduction:**
 - The increased potential amount to recycling has a larger savings impact than the reduction of landfill or thermal treatment. Landfill is relatively neutral (factor of 15 kg CO_{2eq} per tonne compared to -9,457 kg CO_{2eq} per tonne for recycling).
 - Aluminium that ends up in waste-to-energy plants is largely recovered from the bottom ashes and recycled
- **Whether choosing a 20 or a 100-year time horizon**, has only a small effect (<5 Mt CO_{2eq}).
- The **marginal approach** and **derogation option** for the implementation of the municipal waste related targets have no noteworthy effect at the European level.



Wood*

Source: © iStock - clu-min



67.3 Mt

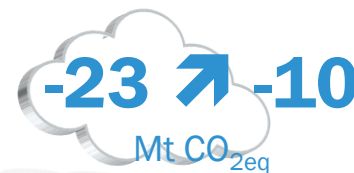
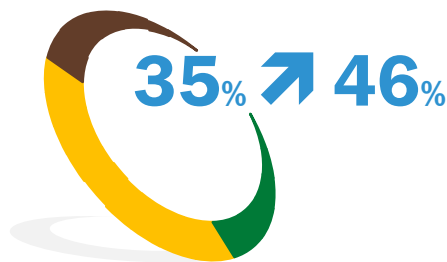

Key results

Wood volume

67 Mt of estimated Wood waste generated and statistically recorded within the EU 27+UK in 2018. Corresponding to an average of 131 kg per inhabitant.

Wood waste is primarily generated by households and industrial sources, but also originates from construction and demolition waste*.

Material recycling

In 2018, approx. 35% (24 Mt) were recycled and 58% (39 Mt) were energy recovered/otherwise thermally treated**.

In the projections, the total material recycling rate was estimated to achieve ~46% by 2035, corresponding to approx. 31 Mt. By decreasing the allocated amount to landfilling, in the more ambitious Projection 2, an approx. potential of 36 Mt is energy recovered.

CO₂ emission savings

While in 2018 the net CO₂ emission savings amounted -23 Mt CO_{2eq}, in Projection 1 the potential savings reduced to -21 Mt CO_{2eq} in 2035. This is primarily the result of a lowered allocation to energy recovery/other thermal treatment for a higher recycling amount. By further increasing recycling and avoiding landfilling the potential reduces to -10 Mt CO_{2eq} by 2035 in Projection 2. Energy recovery/other thermal treatment avoids more emissions than recycling per tonne, but also decreasingly so as the energy mix in Projection 1 and 2 foresees more renewable energy.

*for the allocated EWC-Codes please refer to Annex EWC-Codes
**at point of measurement after sorting

Wood



67

Mt/2018



131

kg/ihn (2018)

Key results

- The ring diagrams (left to right) show an increase in the recycling rate from 35% (24 Mt) to 46% (31 Mt)
- Combustion of wood generates CO₂, which is biogenic CO₂ and is considered neutral and is not taken into account (see p. 33), while the avoidance through energy recovery is considered. Also, wood as a material has a relative low fossil CO₂ footprint. This contributes to the counterintuitive result: less avoided (fossil) CO_{2eq} when more wood is recycled instead of thermal treatment with Energy Recovery/other thermal treatment (i.e. avoiding fossil fuels).
- It is important to note that recycling keeps valuable materials available to the economy, and has a positive effect on other environmental indicators such as land use (e.g. sustainable forest management).

Waste Management Route

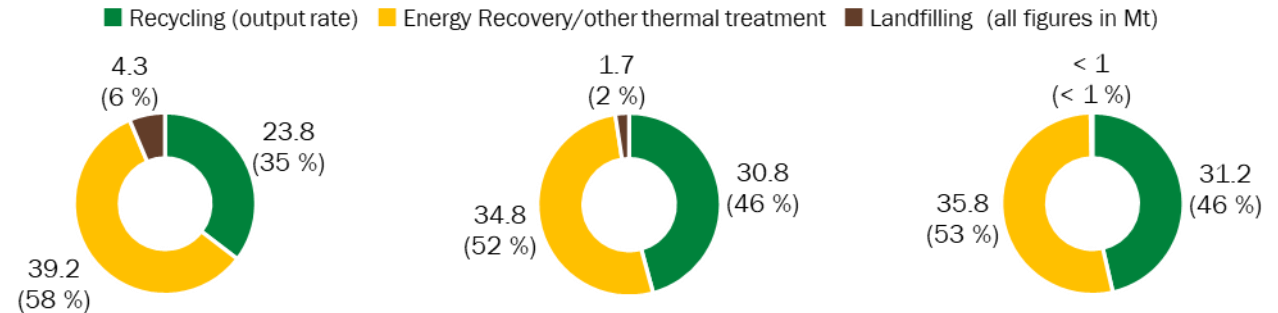

CO_{2eq} Net Emissions

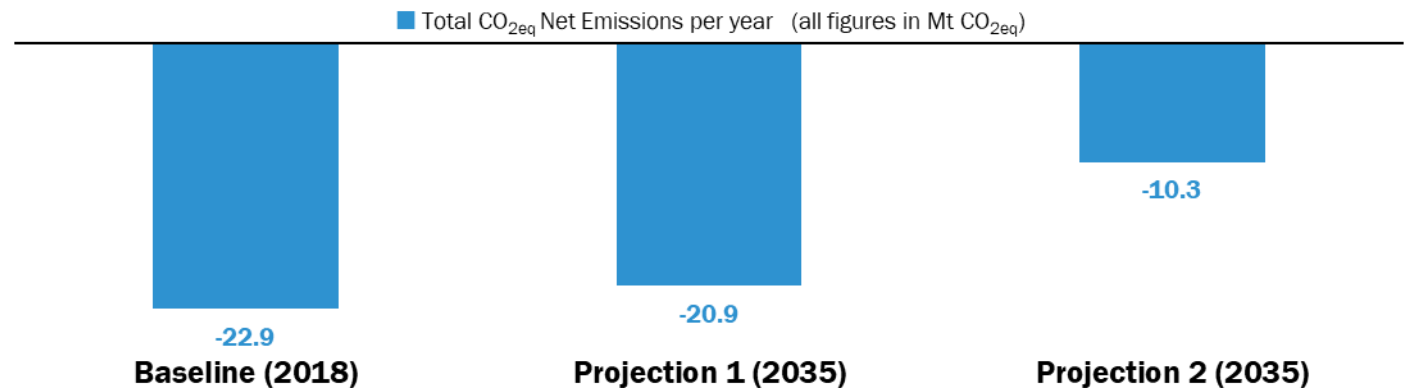

Projection 1 waste targets incl. derogation option. Projection 2 does not consider contingency capacities for landfilling or other wastes requiring landfilling. Recycling figures relate to output rates after sorting losses, in accordance with the legislative point of measurement. 20-year time horizon for greenhouse gas effects in the atmosphere, excl. transport.

Sources: Eurostat, various sources of bibliography; assessment and calculation by Prognos and CE Delft

Waste material and CO₂ reduction potential to protect the climate

- Increase in recycling rate from 35% (24 Mt) to 46% (31 Mt)
 - Decrease in landfill from 6% (4.3 Mt) to:
 - 2% (1.7 Mt) in Projection 1
 - <1% (0.2 Mt) in Projection 2
 - The net CO₂ result in the Baseline is estimated at
 - -23 Mt CO_{2eq}, and increases to
 - -21 Mt CO_{2eq} in Projection 1
 - -10 Mt CO_{2eq} in Projection 2
 - **Primary drivers of the CO₂ reduction are:**
 - Wood presents a counter-intuitive waste stream, as in this case CO₂ emissions increase, primarily as a result of a reduced amount allocated to thermal treatment with more avoided fossil CO₂ than recycling.
 - Emission savings generated by recycling remain relatively stable despite increased volumes allocated to recycling.
 - The effect of reduced volumes to landfill is relatively small, as in the Baseline only a small share is landfilled.
 - It is important to note that recycling keeps valuable materials available to the economy, and has a positive effect on other environmental indicators such as land use (e.g. sustainable forest management).
- **20 or 100-year time horizon** has only a minor effect
 - Baseline: -23 vs -21 Mt CO_{2eq}
 - Projection 1: -21 vs -19 Mt CO_{2eq}
 - Projection 2: -10 vs -10 Mt CO_{2eq}The difference between the 20 and 100-year time horizon originates primarily from a lower avoidance in energy recovery/thermal treatment as the principal treatment path.
 - **20-year time horizon vs the 20-year time horizon marginal approach** improves the thermal CO₂ avoidance factor, due to the avoidance from conventional fossil-based heat and electricity generation:
 - Baseline: -23 vs -51 Mt CO_{2eq}
 - Projection 1: -21 vs -46 Mt CO_{2eq}
 - Projection 2: -10 vs -39 Mt CO_{2eq}
 - The **derogation option** for the implementation of the municipal waste related targets has no noteworthy effect at the European level.



Textiles*

Source: © iStock - vuk8691-min



7.2 Mt

Key results

Textiles' volume

7 Mt of estimated Textile waste generated and statistically recorded within the EU 27+UK in 2018 incl. 0.6 Mt unknown treatment. Corresponding to an average of 15 kg per inhabitant. Textile waste is primarily generated by households and industrial sources*.

Material recycling

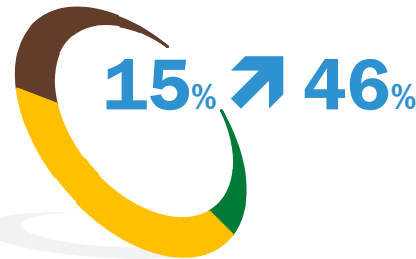

In 2018, approx. 15% (1 Mt) were recycled** and 41% (3 Mt) were energy recovered/otherwise thermally treated. In the projections, the total material recycling rate was estimated to achieve ~46% by 2035, corresponding to approx. 3 Mt. Additional potential originates from 0.6 Mt of currently unknown treated textile wastes.

CO₂ emission savings



While in 2018 the net CO₂ emission burden amounted to -1 Mt CO_{2eq}, in Projection 1 the potential falls to -10 Mt CO_{2eq} in 2035. This is primarily the result of an increase in recycling. In Projection 2 the potential falls to -12 Mt CO_{2eq}. An additional potential of -1.3 Mt CO_{2eq} originates from the currently unknown treated textile wastes if treated in the EU as in Projection 2.

*for the allocated EWC-Codes please refer to Annex EWC-Codes
**at point of measurement after sorting

Textiles



7

Mt/2018



15

kg/ihn (2018)

Key results

- Textiles has the lowest recycling rate. It is among the few waste streams with a narrow net zero burden.
- Textile wastes, like for plastic, has a large amount, which is not known how it is treated. It is estimated at 0.6 Mt.
- With the inclusion of the unknown treated amount in the Baseline, the net CO₂ emission is likely to be an overall CO₂ burden.
- Increasing recycling and reducing landfilling has a net CO₂ saving potential of 13 CO_{2eq} Mt.

Sources: Eurostat, various sources of bibliography; assessment and calculation by Prognos and CE Delft

Waste Management Route

■ Recycling (output rate) ■ Energy Recovery/other thermal treatment ■ Landfilling ■ Treatment unknown (all figures in Mt)

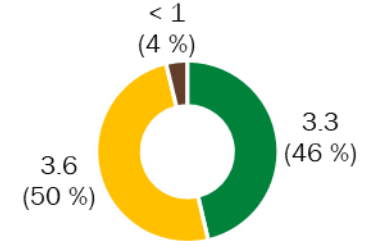
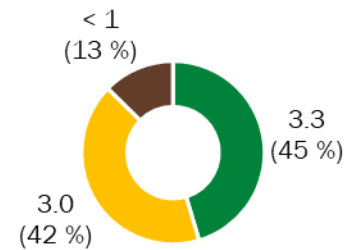
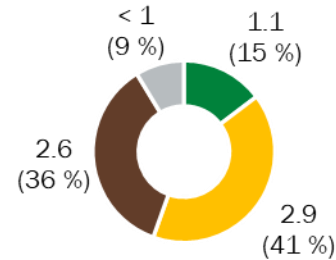

CO_{2eq} Net Emissions

■ Total CO_{2eq} Net Emissions per year ■ CO_{2eq} from unknown treatment (all figures in Mt CO_{2eq})

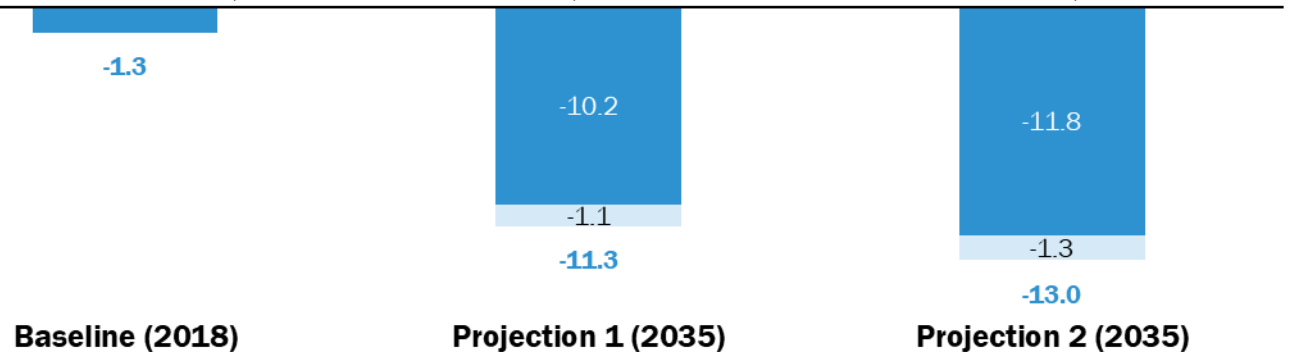

Projection 1 waste targets incl. derogation option. Projection 2 does not consider contingency capacities for landfilling or other wastes requiring landfilling. Treatment unknown not included in Baseline CO₂ estimation. In projections assumed to be treated as in EU, and separately indicated. Recycling figures relate to output rates after sorting losses, in accordance with the legislative point of measurement. 20-year time horizon for greenhouse gas effects in the atmosphere, excl. transport.

Waste material and CO₂ reduction potential to protect the climate

- Textiles has the lowest recycling rate amongst the waste streams.
- An increase in the recycling rate from 15% (1 Mt) to 46% (3 Mt) is estimated and a decrease in landfill from 36% (2.6 Mt) to:
 - 13% (0.7 Mt) in Projection 1
 - 4% (0.2 Mt) in Projection 2
- Net CO₂ avoidance in the Baseline is estimated at
 - -1.3 Mt CO_{2eq}(excl. unknown treatment) and, falls to
 - -10.2 Mt CO_{2eq}, in Projection 1 (excl. unknown treatment)
 - -11.8 Mt CO_{2eq}, in Projection 2 (excl. unknown treatment)
- Accounting for the unknown treatment,
 - -11.3 Mt CO_{2eq}, in Projection 1
 - -13.0 Mt CO_{2eq}, in Projection 2incl. the unknown treated textile waste is likely to render the Baseline to a net emission burden.

- **Primary drivers of the CO₂ reduction:**
 - The increased amount allocated to recycling leads to an overall higher CO₂ saving than its overall treatment.
 - The reduced amount allocated to landfill reduces the burden by ~3.7 Mt CO_{2eq} in Projection 2 compared to the Baseline (exclude. unknown treatment)
 - Savings from energy recovery/other thermal treatment remain relatively stable between Projection 1 and 2 despite an increase in waste allocated to energy recovery/other thermal treatment, as the CO₂ avoidance factor is lowered.
- **Whether choosing a 20-year or 100-year time horizon**, has only a small effect
 - Baseline: -1.3 vs -3 Mt CO_{2eq}
 - Projection 1: -11.3 vs -10.3 Mt CO_{2eq} (incl. unknown treatment)
 - Projection 2: -13.0 vs -11.3 Mt CO_{2eq} (incl. unknown treatment)
- In the Baseline the savings are higher in the 100-year time horizon as a result of the landfill burden being smaller, thus yielding more avoidance overall than in the 20-year perspective. This effect is reduced in the projections with the smaller amount allocated to landfill, so that overall net avoidance is higher in the 20-year perspective.
- The marginal approach increases the avoidance of the 20-year perspective by around 1-3 Mt CO_{2eq}, as a result of the energy recovery/other thermal treatment.
- The **derogation option** for the implementation of the municipal waste related targets has no noteworthy effect.

Source: various sources as of bibliography, assessment and calculation by Prognos and CE Delft



Biowaste*

Source: © AdobeStock - Annett Seidler-min

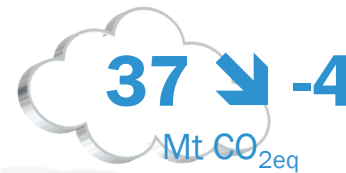
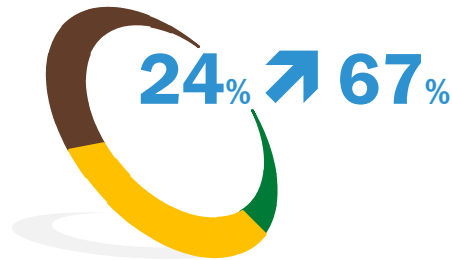
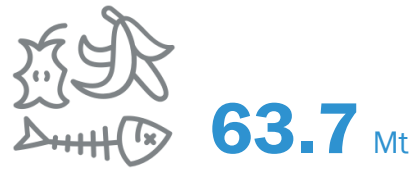

Key results

Biowaste volume

64 Mt of estimated biowaste waste generated and statistically recorded within the EU 27+UK in 2018. Corresponding to an average of 124 kg per inhabitant. Biowaste waste is primarily generated by households and industrial sources.

Composting & anaerobic digestion*

In 2018, approx. 24% (15 Mt) were composted/anaerobically digested and 41% (26 Mt) were energy recovered/otherwise thermally treated**. In the projections, the total potential material composted/anaerobically digestion rate was estimated to achieve ~67% by 2035, corresponding to approx. 42 Mt. By decreasing the allocated amount to landfilling, in the more ambitious Projection 2, approx. 21 Mt are allocated to energy recovery/other thermal treatment.

CO₂ emission savings

While in 2018 the net CO₂ emission burden amounted to 37 Mt CO_{2eq}, in Projection 1 it falls to 5 Mt CO_{2eq} in 2035. This is primarily the result of a lowered allocation to landfilling. By further avoiding landfilling of biowaste, potential net emissions of approx. -4 Mt CO_{2eq} are achieved by 2035 in Projection 2. This presents the second largest net CO₂ saving potential amongst the selected material waste streams.

*for the allocated EWC-Codes please refer to Annex EWC-Codes
**at point of measurement after sorting

Biowaste



64

Mt/2018



124

kg/i/hn (2018)

Waste Management Route

■ Composting/anaerobic digestion (output rate) ■ Energy Recovery/other thermal treatment ■ Landfilling (all figures in Mt)

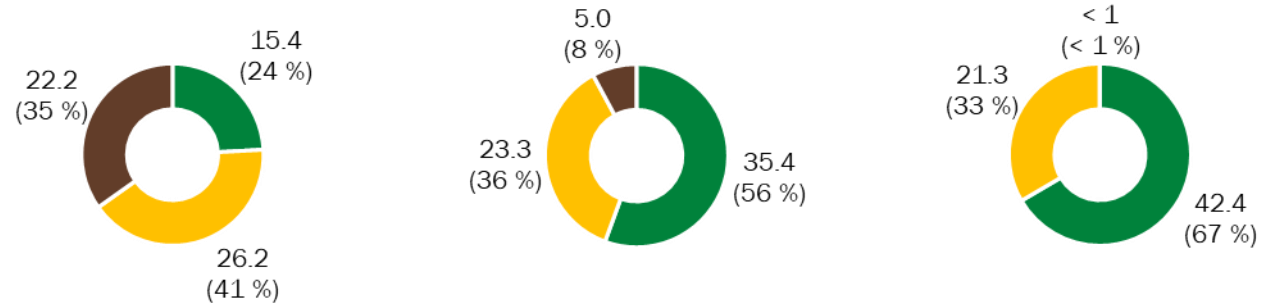

CO_{2eq} Net Emissions

■ Total CO_{2eq} Net Emissions per year (all figures in Mt CO_{2eq})

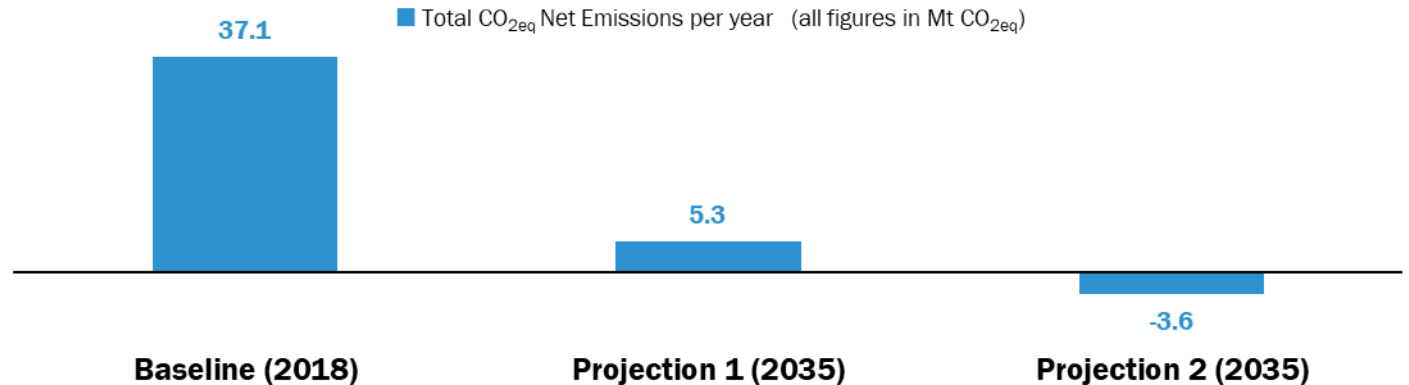

Projection 1 waste targets incl. derogation option. Projection 2 does not consider contingency capacities for landfilling or other wastes requiring landfilling. Composting/anaerobic digestion figures relate to output rates after sorting losses, in accordance with the legislative point of measurement. 20-year time horizon for greenhouse gas effects in the atmosphere, excl. transport. Composting/anaerobic digestion does not include home composting.

Key results

- Biowaste has the second largest positive net CO₂ burden amongst the selected waste streams.
- By reducing landfilling this waste stream could achieve a near net zero CO₂ burden. Net savings are achieved by composting/anaerobic digestion and energy recovery/other thermal treatment.

Sources: Eurostat, various sources of bibliography; assessment and calculation by Prognos and CE Delft

Waste material and CO₂ reduction potential to protect the climate

- Biowaste has the second largest positive CO₂ burden amongst the selected waste streams.
- An increase in composting/anaerobic digestion rate from 24% (15 Mt) to 67% (42 Mt) potential is estimated and a decrease in landfill from 35% (22 Mt) to:
 - 8% (5 Mt) in Projection 1
 - <1% (<0.1 Mt) in Projection 2
- The CO₂ burden in the Baseline is estimated at
 - 37.1 Mt CO_{2eq} and falls to
 - 5.3 Mt CO_{2eq} in Projection 1
 - -3.6 Mt CO_{2eq} in Projection 2
- **Primary drivers of the CO₂ reduction:**
 - The reduced allocation to landfill yields large CO₂ burden reductions, such as in the form of methane emissions.
 - Small additional net savings are achieved with higher composting/anaerobic digestion rates.
 - Small net savings from energy recovery/other thermal treatment are reduced as less is treated, but compared to landfill CO₂ burden these remain small and relatively stable.
 - Although the carbon impact of composting/anaerobic digestion is only somewhat larger than thermal treatment, composting has a strong preference from a waste hierarchy point of view and from a need for fertilizers with a high organic content.
- **20 or 100-year time horizon**, has a noticeable effect
 - Baseline: 37 vs 9.8 Mt CO_{2eq}
 - Projection 1: 5 vs -1.5 Mt CO_{2eq}
 - Projection 2: -4 vs -4.5 Mt CO_{2eq}
- The effect of the 100-year perspective is noticeable, and primarily a result of the CO₂ factor for the landfill burden, which is markable lower in the 100-year perspective, as the emissions' warming potential effect in the atmosphere are spread over a longer time period.
- **20-year time horizon vs the 20-year time horizon marginal approach**, has a noticeable effect
 - Baseline: 37 vs 33.2 Mt CO_{2eq}
 - Projection 1: 5 vs 1.8 Mt CO_{2eq}
 - Projection 2: -4 vs -6.5 Mt CO_{2eq}
- The **derogation option** for the implementation of the municipal waste related targets has no noteworthy effect.

Source: various sources as of bibliography, assessment and calculation by Prognos and CE Delft



Waste Tyres*

Source: © AdobeStock - Syda Productions-min



3.1 Mt

Key results

Waste tyres' volume

3 Mt of estimated waste tyres generated and statistically recorded within the EU 27+UK in 2018. Corresponding to an average of 6 kg per inhabitant. Waste tyres are primarily generated by vehicles from households and industries.

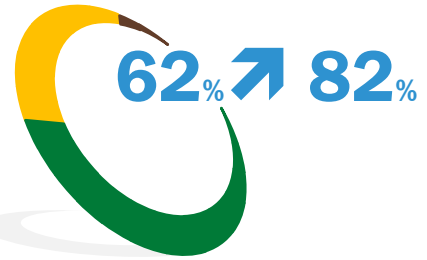

Material recycling

In 2018, approx. 62% (2 Mt) were recycled and 38% (1 Mt) were energy recovered/otherwise thermally treated**. In the projections, the potential total material recycling rate was estimated to achieve ~82% by 2035, corresponding to approx. 3 Mt. A potential of approx. 1 Mt is estimated to be allocated to Energy Recovery/other thermal treatment.

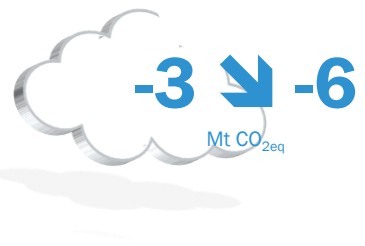

CO₂ emission savings

While in 2018 the net CO₂ emission burden amounted to -3 Mt CO_{2eq}, in Projection 1 it remains at this level. In Projection 2 it falls further to -6 Mt CO_{2eq} by a larger allocation to recycling.

*for the allocated EWC-Codes please refer to Annex EWC-Codes
**at point of measurement after sorting

Waste tyres



3

Mt/2018



6

kg/ihn (2018)

Waste Management Route

■ Recycling (output rate) ■ Energy Recovery/other thermal treatment ■ Landfilling (all figures in Mt)

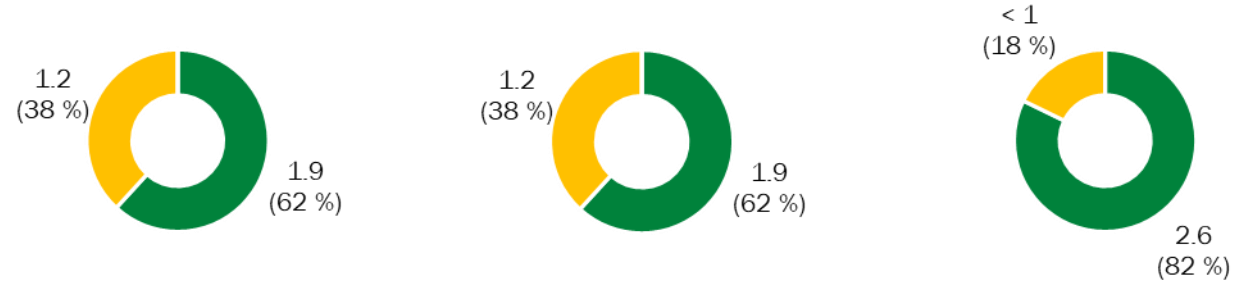

CO_{2eq} Net Emissions

■ Total CO_{2eq} Net Emissions per year (all figures in Mt CO_{2eq})

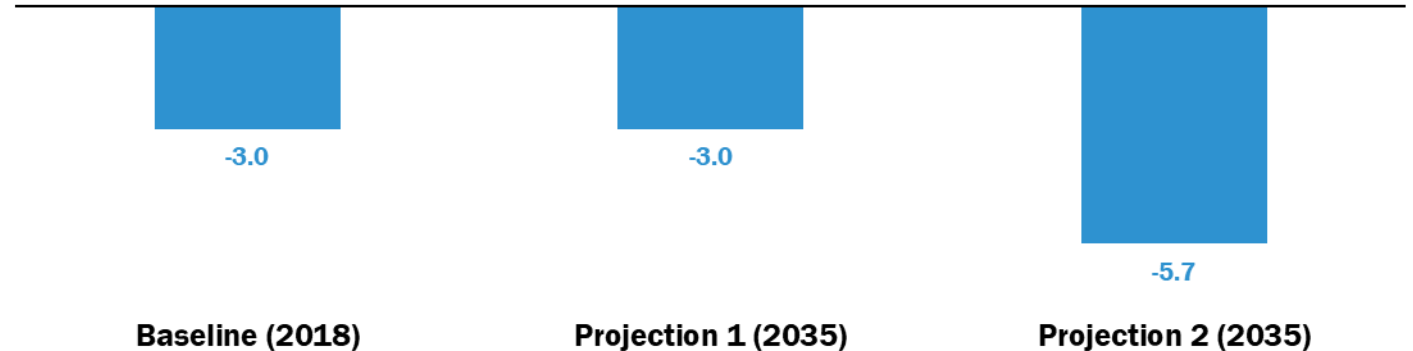

Key results

- The CO₂ burden in the Baseline is estimated at -3 Mt CO_{2eq}, remaining stable in Projection 1. Projection 2 it decreases to -6 Mt CO_{2eq}.
- Primary drivers of the CO₂ reduction: The CO₂ savings in Projection 2 result from additional volumes of waste tyres being recycled rather than being thermally treated.

Projection 1 waste targets incl. derogation option. Projection 2 does not consider contingency capacities for landfilling or other wastes requiring landfilling. Recycling figures relate to output rates after sorting losses, in accordance with the legislative point of measurement. 20-year time horizon for greenhouse gas effects in the atmosphere, excl. transport.

Sources: Eurostat, ETRMA, various sources of bibliography; assessment and calculation by Prognos and CE Delft

Waste tyres

Waste material and CO₂ reduction potential to protect the climate

- Increase in the recycling rate from 62% (1.9 Mt) to 82% (2.6 Mt).
- CO₂ burden in the Baseline estimated at -3 Mt CO_{2eq}, remaining stable in Projection 1. In Projection 2 the potential decreases to -6 Mt CO_{2eq}.
- **Primary drivers of the CO₂ reduction:**
 - The CO₂ savings in Projection 2 result from additional waste tyres volumes being recycled rather than being energy recovered/otherwise thermally treated.
- **20 or 100-year time horizon**, has a very small effect
 - Baseline: -3 vs -2.6 Mt CO_{2eq}
 - Projection 1: -3 vs -2.6 Mt CO_{2eq}
 - Projection 2: -5.7 vs -5.5 Mt CO_{2eq}
- Life-cycle data is not available for the calculation of the **marginal approach** in the 20-year time horizon and is, thus, not calculated.
- The **derogation option** for the implementation of the municipal waste related targets has no noteworthy effect.

Main Results for Residual Waste/WDF

06



Total Residual wastes/WDF*

Source: Ralf Breer



237 ↘ **190** Mt

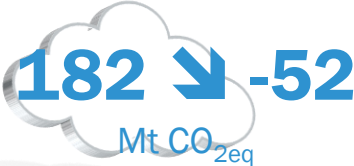
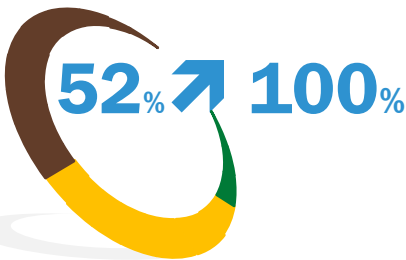

Key results

Residual Waste/WDF's volume

237 Mt⁺⁺⁺ of estimated waste derived fuels and residual waste are generated and statistically recorded within the EU 27+UK in 2018, corresponding to an average of 462 kg per inhabitant. The residual wastes/WDF in this study are comprised by sorting residues (W103), municipal residual wastes (non-recycled municipal waste), and sorting and recycling losses from the selected material waste streams. The material waste stream projections, thus, influence waste volumes of the residual wastes/WDF.

Energy Recovery/other thermal treatment

In 2018, approx. 52% (123 Mt) residual wastes/WDF were energy recovered/otherwise thermally treated^{***}. The remainder is allocated to landfill. In Projection 2 fractions suitable for thermal treatment are no longer allocated to landfill. Landfilling of specific residual wastes/WDF that remain necessary in the future (e.g., after flood disasters) are not part of this study.

CO₂ emission savings

While in 2018 the net CO₂ emission burden amounted to 182 Mt CO_{2eq}, in Projection 1 it falls to Mt 120 CO_{2eq} in 2035. This is also a result of less residual wastes/WDF being available, as more wastes are sorted out for recycling. By allocating residual wastes/WDF to Energy Recovery/other thermal treatment in Projection 2, the CO₂ emissions falls to -52 Mt CO_{2eq}.

^{***} Overlap with material waste streams results from the non-recycled municipal waste part, and sorting and recycling losses.
^{*}residual wastes/WDF refers to the waste derived fuels and residual waste as defined in the Annex for the allocated EWC-Codes please refer to Annex EWC-Codes

Residual waste and waste derived fuels totals



Key results

- Residual waste/WDF include the sorting losses from the selected waste streams and non-recycled municipal waste. The amount, therefore, changes with the projections: new sorting losses are added, and residual waste reduced, as more municipal residual waste are recycled. This interaction lets the residual waste volume decline overall.
- Combined with the increased amount allocated to Energy Recovery/other thermal treatment, the net CO₂ emissions substantially fall from 182 Mt CO_{2eq} in the Baseline to -52 Mt CO_{2eq} in the Projection 2.
- Landfilling of specific residual wastes/WDF will still be necessary (e.g. asbestos). Such specific waste streams are not part of the scope of this study. Certain contingency planning capacities will also be needed, which has also not been considered. A complete discontinuity of landfilling is not realistically possible.

* year refers to the projection year, while the waste volume is held constant at the level of 2018.

Sources: Eurostat, various sources of bibliography; assessment and calculation by Prognos and CE Delft

Waste Management Route

■ Recycling (output rate) ■ Energy Recovery/other thermal treatment ■ Landfilling (all figures in Mt)

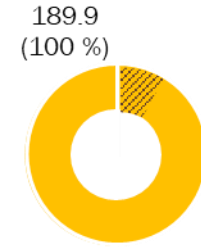
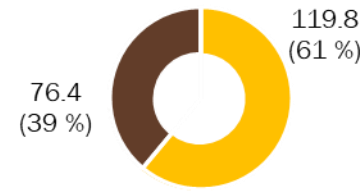
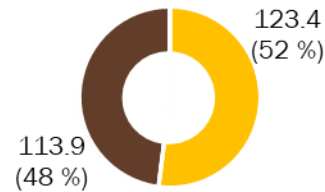

ⁱ As the statistical category „sorting residues“ contains also smaller amounts of waste types, which may not be suitable for Energy Recovery/other thermal treatment, landfilling will remain needed. It is not included in the presented calculation and only marked up indicatively.

CO_{2eq} Net Emissions

■ Total CO_{2eq} Net Emissions per year (all figures in Mt CO_{2eq})

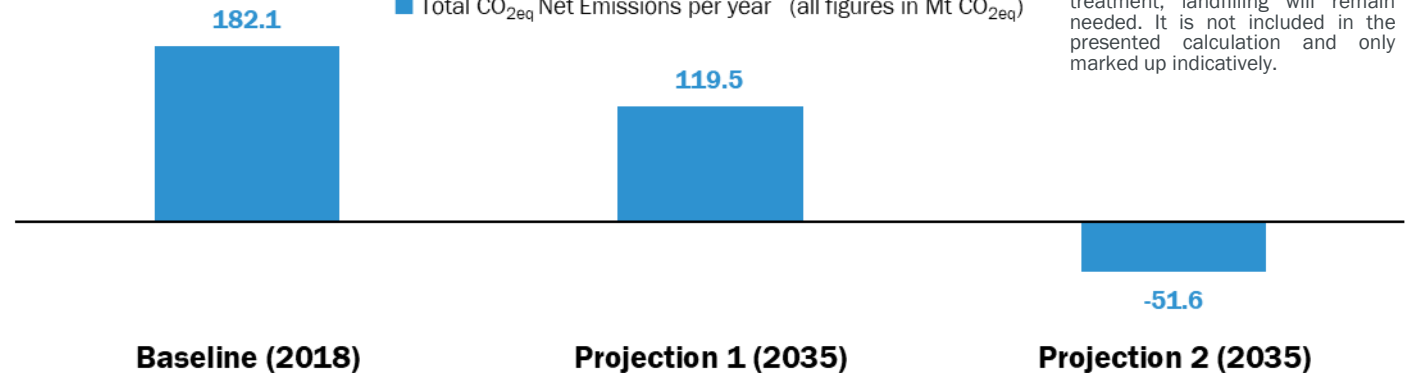

Projection 1 waste targets incl. derogation option. Projection 2 does not consider contingency capacities for landfilling or other wastes requiring landfilling. Treatment unknown not included in Baseline CO₂ estimation. In projections assumed to be treated as in EU, and separately indicated. The overall waste volume marginally decreases as other material wastes (not covered) in the municipal waste are also recycled, which in turn lowers the modelled waste volume amount and, therewith, the considered residual wastes/WDF, while the selected material waste stream volume is held constant. The overlap with material waste streams is included in these figures. They cannot be added together with the figures for the material waste streams, thus are provided as a separate combined total (slide 51-54).

Residual waste and waste derived fuels totals

Energy recovery/other thermal treatment and CO₂ reduction potential to protect the climate

- The total amount of residual wastes/WDF decreases from 237 Mt to 190 Mt. With increasing recycling of the selected waste streams more residual waste in form of sorting and recycling losses are generated, which are included in the waste derived fuels. At the same time, with increased volumes being recycled other residual wastes decrease, while additional recycling losses are generated.
- The included residual wastes/WDF (waste derived fuels and residual wastes) are comprised by sorting residues (W103), paper sludges not suitable to be considered under paper & cardboard material waste stream, municipal residual wastes (non-recycled municipal waste), and the sorting and recycling losses from the selected material waste streams.
- Given their difference in quality and, thus, treatment routes (e.g. lower calorific value to WtE plants, higher calorific value to cement kilns), different treatment routes were allocated. Hereby it was not considered that residual wastes/WDF that arise from high calorific value WDF production are landfilled.
- With the increase in the energy recovery/other thermal treatment rate from 52% (123 Mt) to 61% (120 Mt) to a complete allocation to energy recovery/other thermal treatment with 190 Mt, substantial net CO₂ emissions can be avoided. The most CO₂ savings arise from not allocating the residual wastes to landfilling. Given the different energy recovery/other thermal treatment routes, the modelled net CO₂ emission avoidance remain in sum modest, although higher for energy recovery/other thermal treatment by co-incineration. Consideration is given to the fact that a fraction of those residual wastes/WDF, variable across EU, not suitable for combustion according to national rules, will still need to be allocated to landfills.
- The net CO₂ burden in the Baseline is estimated at
 - 182 Mt CO_{2eq} and falls to
 - 120 Mt CO_{2eq} in Projection 1
 - -52 Mt CO_{2eq} in Projection 2
- **Primary drivers of the CO₂ reduction:**
 - The net CO₂ savings are a result of a reduced allocation to landfill. This is particularly pronounced in the shift from Projection 1 to Projection 2.
 - Also less residual wastes/WDF are available, as more wastes are sorted out for recycling, which affect the CO₂ emissions.
 - Changing CO₂ factors interplay between the allocated fractions to incineration and co-incineration, which also affect the emissions.
- **20 or 100-year time horizon**, has a noticeable effect
 - Baseline: 182 vs 59 Mt CO_{2eq}
 - Projection 1: 120 vs 41 Mt CO_{2eq}
 - Projection 2: -52 vs -32 Mt CO_{2eq}
- The effect of the 100-year perspective is primarily the result of the CO₂ factor for landfill, which is lower in the 100-year perspective, as the emissions' effect in atmosphere is spread over a longer time period. This is also the case for energy recovery/other thermal treatment, which explains higher avoidance in the 20-year perspective than the 100-year time horizon (see Projection 2).
- **20-year time horizon vs the 20-year time horizon marginal approach** has an even stronger contrast highlighting the benefits of energy recovery/other thermal treatment of waste compared to fossil fuel-based energy.
 - Baseline: 182 vs 140 Mt CO_{2eq}
 - Projection 1: 120 vs 71 Mt CO_{2eq}
 - Projection 2: -52 vs -141 Mt CO_{2eq}

Residual waste and waste derived fuels

Transport sensitivity

- Transport has only a small modelled effect on the net CO₂ emissions. The treatment route and waste it applies to are the most significant levers to influence the CO₂ emissions of the waste management industry.
- For an average distance of 150 km transported by a medium sized truck, the additional emissions are between 6 and 8 Mt CO_{2eq} for the modelled scenarios.
- Simulating the distance for Energy Recovery/other thermal treatment, the additional emissions greatly offset the transport emissions compared to landfilling. To produce as much emissions as one tonne landfilling, one tonne of waste to energy would have to hypothetically travel over 9200 km by truck, with the size of 7.5-16 t, before being treated to have a higher net burden (>1835 kg CO_{2eq}) than waste for landfilling travelling only 150 km by truck.
- Medium-sized trucks (7.5 - 16 t) are more common for the local transport of wastes for landfilling and WtE treatment. For this reason, it was used as the calculation basis, although trucks being used to transport WDF are curtain-side trailers that carry 25 tons of WDF in bales on average. Exceptions are truck transportation with 40-foot containers.
- By factoring in changes in the modal split, especially as distances increase, e.g., with a shift from truck to ship or train (or larger truck), the additional emissions by tonnage is reduced further still. In turn, the wastes for Energy Recovery/other thermal treatment can travel further before being a net burden or emitting as much or more emissions as a local landfill.

CO_{2eq} net emissions per tonne of material treated incl. transport by truck 7.5 t - 16 t

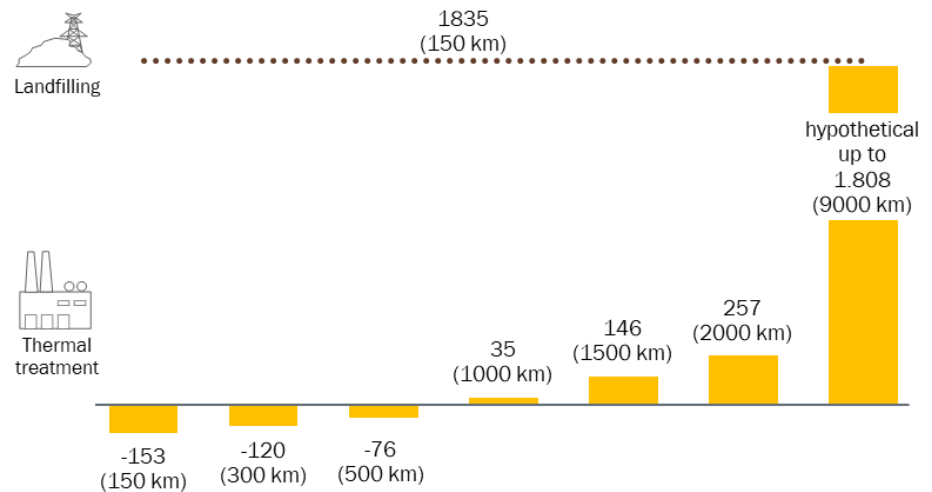

figures in kg CO_{2eq} (information in brackets refer to the corresponding transport distance)

Key Observations

07

Key observations and conclusions

For the selected waste streams, the waste management industry including its post-processing usage is already almost climate neutral and will contribute in the projections to a significant net CO₂ emission saving

01 Cross-sectoral waste management industry: This study, building on the previous study (2008), sheds light on the waste management industry's treatment volumes and associated net CO₂ emissions of selected waste streams. Given their cross-industrial interlinkages, to, for example, other manufacturing industries or the energy generation, their CO₂ contributions are often incomplete, as avoided emissions are attributed to other industries. The waste management industry fulfills, however, an important role in making wastes available as a secondary resource for material and energy use i.e. the collection and transport of wastes, the mechanical (mechanical-biological, mechanical physical-physical) and chemical-physical (pre-)treatment, material and energetic recovery, thermal disposal, and landfilling of wastes that cannot be recovered. This study highlighted the important contributions the waste management industry is making towards key European Union policy objectives accounting for avoided emissions for selected waste streams.

02 Almost net CO₂ neutral: Compared to the previous study (2008) the waste management industry has shown far reaching improvements in recycling rates and in reducing CO₂ emissions. In the 20-year GWP, the waste industry is for the selected waste streams almost CO₂ net neutral (13 Mt CO_{2eq}). Considering only the selected 9 material waste streams, the waste management industry is already contributing to avoiding -96 Mt CO_{2eq} more than it is producing. In so doing the waste management industry is making key contributions to climate action to limit climate warming, as one of the European Union's policy priorities, and to transitioning to a circular economy to reduce pressure on natural resources.

03 Potentials in recycling and CO₂ avoidance to protect the climate: By successfully applying current waste legislation (Projection 1) by 2035 across the EU27+UK the waste recycling potential and CO₂ emission avoidance potential is significantly increased to -137 Mt CO_{2eq}, delivering a potential saving of ~150 Mt CO_{2eq} in Projection 1. The CO₂ net emission burden of 13 Mt CO_{2eq} could drop to -283 Mt CO_{2eq} net emission avoidance in the more ambitious projection 2, delivering an additional potential saving of ~146 Mt CO_{2eq}. To achieve maximum CO₂ avoidance policy makers are, therefore, advised to make optimal use of all available capacity for recycling and waste-to-energy within EU27+UK.

04 Recycling already a net CO₂ avoider: The current largest net emission savings (negative) are achieved by the recycling of the ferrous metal and aluminium waste streams by avoiding significant emissions by the avoidance of primary material production. Combined their net emissions already make up -180 Mt CO_{2eq}, with the potential to fall to -200 Mt CO_{2eq} under the current legislation projection for 2035. Metal recycling takes place via source separation, sorting processes and from bottom ash after incineration processes.

Key observations and conclusions

Metal recycling is the current big CO₂ emission avoider, while the largest future emission reduction potentials lie in diverting waste from landfill up the waste hierarchy

05

The CO₂ reduction potential of the current legislation by 2035: The current legislation has the potential to achieve significant additional emission avoidance across the selected material waste streams. The largest emission reductions are achieved by diverting organic waste streams - paper & cardboard and biowaste - from landfill, which cause significant amounts of methane emissions. This decreases the carbon emissions by a potential of 90 Mt CO_{2eq} from the baseline compared to the current 2035 legislation scenario.

06

Additional potentials beyond the current legislation: Significant additional emission reduction potentials in projection 2 are achieved by diverting residual waste from landfill, aside marginal additional reductions from increased recycling of material waste streams. A net CO_{2eq} emission avoidance potential of -283 Mt CO_{2eq} can be achieved; an avoidance increase of 146 Mt CO_{2eq} compared to the current legislation projection for 2035. 76% of these emissions savings are estimated to be achieved by diverting residual waste from landfill, which can be achieved partly through the production of WDF, which are then sent to energy recovery/other thermal treatment. It is important to note that there are some caveats about the limits of landfill diversion for some waste types.

07

Choice of the Global Warming Potential matters for the size not the direction of change: The study selected the 20-year global warming potential time horizon to reflect the urgency for substantial climate action on methane emissions as suggested by recent studies from the IPCC and United Nations also reflected in the Global Methane Pledge. The CO₂ burden of landfilling for the waste streams is subsequently significantly greater (236 Mt CO_{2eq}) in the Baseline i.e. more immediate, than in the conventional 100-year time (81 Mt CO_{2eq}) horizon. Thus, the Baseline has a higher burden, while in the Projections 2 the avoidance is greater (-283 vs - 250 Mt CO_{2eq}) as the net avoidance is also more immediate.

08

Transport has only a minor role in CO₂ emissions: The role of transport is one of the many areas in which additional CO₂ emission reductions can be achieved. The simulation for residual waste, which is usually transported in the form of WDF, however, indicates that transport is a negligible factor in the overall CO₂ emissions of waste treatment. Moving residual waste up the waste hierarchy into energy recovery/other thermal treatment is the most significant lever to influence the CO₂ emissions of the waste management industry, not reducing transport distances.

Key observations and conclusions

Additional potentials to protect the climate can be leveraged by...

09 **More ambition:** To achieve a greater overall reduction, while increasing especially material reuse, further agile developments to realize additional potential are needed. The savings achieved by using secondary raw materials and by the provision of energy will become increasingly important for the achievement of the climate protection goals. In this manner, the waste management industry including its post-processing usage will not only be climate-neutral, but also make negative contributions to the CO₂ emission balance of the EU. To achieve the more ambitious projections, the municipal waste targets need to be extended to industrial and commercial wastes, and waste streams suitable for recycling and energy recovery/other thermal treatment should be diverted from landfill into these treatment routes. It is recognized that landfill will remain necessary to treat some specific waste types. This was, however, outside the scope of this study.

10 **Not forgetting other objectives:** It is important to recall that net CO₂ avoidance is not the sole objective and needs to be contrasted against other environmental, but also social and economic, objectives. Besides climate change savings, reduced fossil fuel consumption and keeping materials available in the economy via recycling leads also to benefits in other environmental indicators, such as land use, particulate matter formation, acidification and eutrophication. Considering the waste hierarchy and increased circularity, recycling is the more favorable option from a resource perspective.

11 **Improving the data:** The above analysis can only provide an orientation as the current data situation leaves much to be desired. The study revealed a need for greater detail in statistical data across EU Member States. It was found that the availability of data in EWC at LoW level has declined since 2008. Gaps, omissions, and inconsistencies in available data require attention. These are important to achieve a robust allocation of wastes to type of treatment, especially by material. As the point of measurement shifts from an input recycling to an output-based recycling calculation methodology, the importance increases not just for the robust estimation of CO₂ emissions, but also for the recycling rates. This study applied the most feasible estimation methodology given the scope of and resources and data available for this study. The availability of data at only a high aggregation level, the pre-recycling output point of measurement of the statistical data, and data gaps between generation and treatment have necessitated assumptions on the treatment routes described in the methodology. These may have led, in particular in the case of construction and demolition waste, to a minor overestimation of energy recovery/other thermal treatment relative to the other treatment routes in the baseline. The selection of data, choices on treatment of the data and applied methodology may, therefore, lead to differences with other studies, particularly studies conducted at the country-level for the few countries that are able to draw out country specific details.

Annex

Annex A1

Allocation of EWC-Codes to Waste Streams

Allocation of EWC-codes to waste streams

Paper & Cardboard

EWC code		Share of EWC	EWC-Stat-code	
030399	wastes not otherwise specified	complete	W072	Paper and cardboard wastes
150101	paper and cardboard packaging	complete	W072	Paper and cardboard wastes
191201	paper and cardboard	complete	W072	Paper and cardboard wastes
200101	paper and cardboard	complete	W072	Paper and cardboard wastes
200301	mixed municipal waste	pro rata	W101	Household and similar wastes
200307	bulky waste	pro rata	W101	Household and similar wastes
150105	composite packaging	pro rata	W102	Mixed and undifferentiated materials
150106	mixed packaging	pro rata	W102	Mixed and undifferentiated materials
170904	mixed construction and demolition wastes other than those mentioned in 17 09 01, 17 09 02 and 17 09 03	pro rata	W121	Mineral waste from construction and demolition

Notes

- The data for the waste stream paper, cardboard and cardboard packaging is only available in aggregated form at the level of the EWC-Stat codes via Eurostat. In addition to primary waste from different areas of origin, these also include secondary waste that can be allocated to the waste stream, but which can no longer be directly allocated to the primary areas of origin.
- For the modelling of the waste stream paper, cardboard and cardboard packaging, the EWC-Codes statistically recorded in the EWC-Stat group W072 - paper and cardboard wastes were considered (grey background).
- However, the total sum of EWC-Stat group W072 was adjusted by EWC-code 03 03 10, as these are fibre rejects, fibre-, filler- and coating-sludges from mechanical separation, which are to be assigned to the residual waste stream.
- Further potentials were identified in mixed waste. Assumptions were made for the respective shares in the waste mixtures based on an average waste composition and assumptions on the quantities already statistically recorded in the EWC-Stat group.

*indicates hazardous waste

Source: [Eurostat 2018], additional research and assessment by Prognos

Allocation of EWC-codes to waste streams

Glass

EWC code		Share of EWC	EWC-Stat-code	
101111*	waste glass in small particles and glass powder containing heavy metals (e.g. from cathode ray tubes)	complete	W071	Glass wastes
101112	waste glass other than those mentioned in 10 11 11	complete	W071	Glass wastes
150107	glass packaging	complete	W071	Glass wastes
160120	glass	complete	W071	Glass wastes
170202	glass	complete	W071	Glass wastes
191205	glass	complete	W071	Glass wastes
200102	glass	complete	W071	Glass wastes
160104*	end-of-life vehicles	pro rata	W081	Discarded vehicles
160106	end-of-life vehicles, containing neither liquids nor other hazardous components	pro rata	W081	Discarded vehicles
200301	mixed municipal waste	pro rata	W101	Household and similar wastes
200307	bulky waste	pro rata	W101	Household and similar wastes
170204*	glass, plastic and wood containing or contaminated with dangerous substances	pro rata	W121	Mineral waste from construction and demolition
170904	mixed construction and demolition wastes other than those mentioned in 17 09 01, 17 09 02 and 17 09 03	pro rata	W121	Mineral waste from construction and demolition

Notes

- The data for the waste stream glass wastes is only available in aggregated form at the level of the EWC-Stat codes via Eurostat. In addition to primary waste from different areas of origin, these also include secondary waste that can be allocated to the waste stream, but which can no longer be directly allocated to the primary areas of origin.
- For the modelling of the waste stream glass waste, the EWC-Codes statistically recorded in the EWC-Stat group W071 – glass wastes were considered (grey background).
- The EWC-Stat group W071 was, thus, completely recorded.
- Further potentials were identified in mixed waste. Assumptions were made for the respective shares in the waste mixtures based on an average waste composition and assumptions on the quantities already statistically recorded in the EWC-Stat group.

*indicates hazardous waste

Source: [Eurostat 2018], additional research and assessment by Prognos

Allocation of EWC-codes to waste streams

Plastics

EWC code		Share of EWC	EWC-Stat-code	
020104	waste plastics (except packaging)	complete	W074	Plastic wastes
070213	waste plastic	complete	W074	Plastic wastes
120105	plastics shavings and turnings	complete	W074	Plastic wastes
150102	plastic packaging	complete	W074	Plastic wastes
160119	plastic	complete	W074	Plastic wastes
170203	plastic	complete	W074	Plastic wastes
191204	plastic and rubber	complete	W074	Plastic wastes
200139	plastics	complete	W074	Plastic wastes
160104*	end-of-life vehicles	pro rata	W081	Discarded vehicles
160106	end-of-life vehicles, containing neither liquids nor other hazardous components	pro rata	W081	Discarded vehicles
200301	mixed municipal waste	pro rata	W101	Household and similar waste
200307	bulky waste	pro rata	W101	Household and similar wastes
150105	composite packaging	pro rata	W102	Mixed and undifferentiated materials
150106	mixed packaging	pro rata	W102	Mixed and undifferentiated materials
170904	mixed construction and demolition wastes other than those mentioned in 17 09 01, 17 09 02 and 17 09 03	pro rata	W121	Mineral waste from construction and demolition

*indicates hazardous waste

Source: [Eurostat 2018], additional research and assessment by Prognos

Notes

- The data for the waste stream plastic wastes is only available in aggregated form at the level of the EWC-Stat codes via Eurostat. In addition to primary waste from different areas of origin, these also include secondary waste that can be allocated to the waste stream, but which can no longer be directly allocated to the primary areas of origin.
- For the modelling of the waste stream plastic waste, the EWC-Codes statistically recorded in the EWC-Stat group W074 – plastic wastes were considered (grey background).
- The EWC-Stat group W074 was thus completely recorded.
- Further potentials were identified in mixed waste. Assumptions were made for the respective shares in the waste mixtures based on an average waste composition and assumptions on the quantities already statistically recorded in the EWC-Stat group.

Allocation of EWC-codes to waste streams

Ferrous metals (1/2)

EWC code		Share of EWC	EWC-Stat-code	
100210	mill scales	complete	W061	Metal wastes, ferrous
101206	discarded molds	complete	W061	Metal wastes, ferrous
120101	ferrous metal filings and turnings	complete	W061	Metal wastes, ferrous
120102	ferrous metal dust and particles	complete	W061	Metal wastes, ferrous
160117	ferrous metal	complete	W061	Metal wastes, ferrous
170405	iron and steel	complete	W061	Metal wastes, ferrous
190102	ferrous materials removed from bottom ash	complete	W061	Metal wastes, ferrous
191001	iron and steel waste	complete	W061	Metal wastes, ferrous
191202	ferrous metal	complete	W061	Metal wastes, ferrous
020110	waste metal	pro rata	W063	Metal wastes, mixed ferrous and non-ferrous
101099	wastes not otherwise specified	pro rata	W063	Metal wastes, mixed ferrous and non-ferrous
150104	metallic packaging	pro rata	W063	Metal wastes, mixed ferrous and non-ferrous
170407	mixed metals	pro rata	W063	Metal wastes, mixed ferrous and non-ferrous
200140	metals	pro rata	W063	Metal wastes, mixed ferrous and non-ferrous
160104*	end-of-life vehicles	pro rata	W081	Discarded vehicles
160106	end-of-life vehicles, containing neither liquids nor other hazardous components	pro rata	W081	Discarded vehicles

*indicates hazardous waste

Source: [Eurostat 2018], additional research and assessment by Prognos

Notes

- The data for the waste stream ferrous metals is only available in aggregated form at the level of the EWC-Stat codes via Eurostat. In addition to primary waste from different areas of origin, these also include secondary waste that can be allocated to the waste stream, but which can no longer be directly allocated to the primary areas of origin.
- For the modelling of the waste stream ferrous metals the respective EWC-Codes are statistically recorded in the EWC-Stat group W061 - Metal wastes, ferrous and W063 - Metal wastes, mixed ferrous and non-ferrous (grey background).
- While EWC-Stat group W061 could be considered completely, for the ferrous metal share in W063 assumptions had to be made
- Further potentials were identified in mixed waste, discarded vehicles and equipment. Assumptions were made for the respective shares both, within the EWC-Codes and in the related EWC-Stat groups. Assumptions are based on average waste compositions available from literature review and interviews and assumptions on the quantities already statistically recorded in the EWC-Stat group.

Allocation of EWC-codes to waste streams

Ferrous metals (2/2)

EWC code		Share of EWC	EWC-Stat-code	
160211*	discarded equipment containing chlorofluorocarbons, HCFC, HFC	pro rata	W08A	Discarded equipment (except discarded vehicles and batteries and accumulators waste) (W08 except W081, W0841)
160213*	discarded equipment containing hazardous components other than those mentioned in 16 02 09 to 16 02 12	pro rata	W08A	Discarded equipment (except discarded vehicles and batteries and accumulators waste) (W08 except W081, W0841)
160214	discarded equipment other than those mentioned in 16 02 09 to 16 02 13	pro rata	W08A	Discarded equipment (except discarded vehicles and batteries and accumulators waste) (W08 except W081, W0841)
160215*	hazardous components removed from discarded equipment	pro rata	W08A	Discarded equipment (except discarded vehicles and batteries and accumulators waste) (W08 except W081, W0841)
160216	components removed from discarded equipment other than those mentioned in 16 02 15	pro rata	W08A	Discarded equipment (except discarded vehicles and batteries and accumulators waste) (W08 except W081, W0841)
200135*	discarded electrical and electronic equipment other than those mentioned in 20 01 21 and 20 01 23 containing hazardous components	pro rata	W08A	Discarded equipment (except discarded vehicles and batteries and accumulators waste) (W08 except W081, W0841)
200136	discarded electrical and electronic equipment other than those mentioned in 20 01 21, 20 01 23 and 20 01 35	pro rata	W08A	Discarded equipment (except discarded vehicles and batteries and accumulators waste) (W08 except W081, W0841)
200301	mixed municipal waste	pro rata	W101	Household and similar wastes
200307	bulky waste	pro rata	W101	Household and similar wastes
120113	welding wastes	pro rata	W102	Mixed and undifferentiated materials
170904	mixed construction and demolition wastes other than those mentioned in 17 09 01, 17 09 02 and 17 09 03	pro rata	W121	Mineral waste from construction and demolition

*indicates hazardous waste

Source: [Eurostat 2018], additional research and assessment by Prognos

Allocation of EWC-codes to waste streams

Aluminium (1/2)

EWC code		Share of EWC	EWC-Stat-code	
170402	aluminium	complete	W062	Metal wastes, non-ferrous
020110	waste metal	pro rata	W063	Metal wastes, mixed ferrous and non-ferrous
101099	wastes not otherwise specified	pro rata	W063	Metal wastes, mixed ferrous and non-ferrous
120103	non-ferrous metal filings and turnings	pro rata	W063	Metal wastes, mixed ferrous and non-ferrous
120104	non-ferrous metal dust and particles	pro rata	W063	Metal wastes, mixed ferrous and non-ferrous
150104	metallic packaging	pro rata	W063	Metal wastes, mixed ferrous and non-ferrous
160118	non-ferrous metal	pro rata	W063	Metal wastes, mixed ferrous and non-ferrous
170407	mixed metals	pro rata	W063	Metal wastes, mixed ferrous and non-ferrous
191002	non-ferrous waste	pro rata	W063	Metal wastes, mixed ferrous and non-ferrous
191203	non-ferrous metal	pro rata	W063	Metal wastes, mixed ferrous and non-ferrous
200140	metals	pro rata	W063	Metal wastes, mixed ferrous and non-ferrous
160104*	end-of-life vehicles	pro rata	W081	Discarded vehicles
160211*	discarded equipment containing chlorofluorocarbons, HCFC, HFC	pro rata	W08A	Discarded equipment (except discarded vehicles and batteries and accumulators waste) (W08 except W081, W0841)
160213*	discarded equipment containing hazardous components other than those mentioned in 16 02 09 to 16 02 12	pro rata	W08A	Discarded equipment (except discarded vehicles and batteries and accumulators waste) (W08 except W081, W0841)

*indicates hazardous waste

Source: [Eurostat 2018], additional research and assessment by Prognos

Notes

- The data for the waste stream aluminium is only available in aggregated form at the level of the EWC-Stat codes via Eurostat. In addition to primary waste from different areas of origin, these also include secondary waste that can be allocated to the waste stream, but which can no longer be directly allocated to the primary areas of origin.
- For the modelling of the waste stream aluminium the respective EWC-Codes are statistically recorded in the EWC-Stat group W062 – Metal wastes, non ferrous and W063 - Metal wastes, mixed ferrous and non-ferrous (grey background).
- Both EWC-Stat groups include also other nonferrous metals as well as, in case of W062, also ferrous metals. Thus for both EWC-Stat groups assumptions had to be made.
- Further potentials were identified in mixed waste, discarded vehicles and equipment. Assumptions were made for the respective shares both, within the EWC-Codes and in the related EWC-Stat groups. Assumptions are based on average waste compositions available from literature review and interviews and assumptions on the quantities already statistically recorded in the EWC-Stat group.

Allocation of EWC-codes to waste streams

Aluminium (2/2)

EWC code		Share of EWC	EWC-Stat-code	
160214	discarded equipment other than those mentioned in 16 02 09 to 16 02 13	pro rata	W08A	Discarded equipment (except discarded vehicles and batteries and accumulators waste) (W08 except W081, W0841)
160215	hazardous components removed from discarded equipment	pro rata	W08A	Discarded equipment (except discarded vehicles and batteries and accumulators waste) (W08 except W081, W0841)
160216	components removed from discarded equipment other than those mentioned in 16 02 15	pro rata	W08A	Discarded equipment (except discarded vehicles and batteries and accumulators waste) (W08 except W081, W0841)
200135*	discarded electrical and electronic equipment other than those mentioned in 20 01 21 and 20 01 23 containing hazardous components	pro rata	W08A	Discarded equipment (except discarded vehicles and batteries and accumulators waste) (W08 except W081, W0841)
200136	discarded electrical and electronic equipment other than those mentioned in 20 01 21, 20 01 23 and 20 01 35	pro rata	W08A	Discarded equipment (except discarded vehicles and batteries and accumulators waste) (W08 except W081, W0841)
200301	mixed municipal waste	pro rata	W101	Household and similar wastes
200307	bulky waste	pro rata	W101	Household and similar wastes
150105	composite packaging	pro rata	W102	Mixed and undifferentiated materials
150106	mixed packaging	pro rata	W102	Mixed and undifferentiated materials
170904	mixed construction and demolition wastes other than those mentioned in 17 09 01, 17 09 02 and 17 09 03	pro rata	W121	Mineral waste from construction and demolition
100305	waste alumina	complete	W12B	Other mineral wastes (W122+W123+W125)

*indicates hazardous waste

Source: [Eurostat 2018], additional research and assessment by Prognos

Allocation of EWC-codes to waste streams

Wood

EWC code		Share of EWC	EWC-Stat-code	
030101	waste bark and cork	complete	W075	Wood wastes
030104*	sawdust, shavings, cuttings, wood, particle board and veneer containing dangerous substances	complete	W075	Wood wastes
030105	sawdust, shavings, cuttings, wood, particle board and veneer other than those mentioned in 03 01 04	complete	W075	Wood wastes
030301	waste bark and wood	complete	W075	Wood wastes
150103	wooden packaging	complete	W075	Wood wastes
170201	wood	complete	W075	Wood wastes
191206*	wood containing dangerous substances	complete	W075	Wood wastes
191207	wood other than that mentioned in 19 12 06	complete	W075	Wood wastes
200137*	wood containing hazardous substances	complete	W075	Wood wastes
200138	wood other than that mentioned in 20 01 37	complete	W075	Wood wastes
200301	mixed municipal waste	pro rata	W101	Household and similar wastes
200307	bulky waste	pro rata	W101	Household and similar wastes
150106	mixed packaging	pro rata	W102	Mixed and undifferentiated materials
170904	mixed construction and demolition wastes other than those mentioned in 17 09 01, 17 09 02 and 17 09 03	pro rata	W121	Mineral waste from construction and demolition

Notes

- The data for the waste stream wood is only available in aggregated form at the level of the EWC-Stat codes via Eurostat. In addition to primary waste from different areas of origin, these also include secondary waste that can be allocated to the waste stream, but which can no longer be directly allocated to the primary areas of origin.
- For the modelling of the waste stream wood waste, the EWC-Codes statistically recorded in the EWC-Stat group W075 – wood wastes were considered (grey background).
- The EWC-Stat group W075 was thus completely recorded.
- Further potentials were identified mainly in mixed municipal and construction and demolition waste. Assumptions were made for the respective shares in the waste mixtures based on an average waste composition and assumptions on the quantities already statistically recorded in the EWC-Stat group.

*indicates hazardous waste

Source: [Eurostat 2018], additional research and assessment by Prognos

Allocation of EWC-codes to waste streams

Textiles

EWC code		Share of EWC	EWC-Stat-code	
040209	wastes from composite materials (impregnated textile, elastomer, plastomer)	complete	W076	Textile wastes
040210	organic matter from natural products (e.g. grease, wax)	complete	W076	Textile wastes
040221	wastes from unprocessed textile fibres	complete	W076	Textile wastes
040222	wastes from processed textile fibres	complete	W076	Textile wastes
150109	textile packaging	complete	W076	Textile wastes
191208	textiles	complete	W076	Textile wastes
200110	clothes	complete	W076	Textile wastes
200111	textiles	complete	W076	Textile wastes
200301	mixed municipal waste	pro rata	W101	Household and similar wastes
200307	bulky waste	pro rata	W101	Household and similar wastes

Notes

- The data for the waste stream textiles is only available in aggregated form at the level of the EWC-Stat codes via Eurostat. In addition to primary waste from different areas of origin, these also include secondary waste that can be allocated to the waste stream, but which can no longer be directly allocated to the primary areas of origin.
- For the modelling of the waste stream textiles waste, the EWC-Codes statistically recorded in the EWC-Stat group W076 – textile wastes were considered (grey background).
- The EWC-Stat group W076 was thus completely recorded.
- Further potentials were identified mainly in mixed municipal waste. Assumptions were made for the respective shares in municipal waste based on an average waste composition and assumptions on the quantities already statistically recorded in the EWC-Stat group.

Source: [Eurostat 2018], additional research and assessment by Prognos

Allocation of EWC-codes to waste streams

Biowaste

EWC code		Share of EWC	EWC-Stat-code	
020102	animal-tissue waste	complete	W091	Animal and mixed food waste
020103	plant-tissue waste	complete	W091	Animal and mixed food waste
020203	materials unsuitable for consumption or processing	complete	W091	Animal and mixed food waste
020302	wastes from preserving agents	complete	W091	Animal and mixed food waste
020304	materials unsuitable for consumption or processing	complete	W091	Animal and mixed food waste
020501	materials unsuitable for consumption or processing	complete	W091	Animal and mixed food waste
020601	materials unsuitable for consumption or processing	complete	W091	Animal and mixed food waste
020701	wastes from washing, cleaning and mechanical reduction of raw materials	complete	W091	Animal and mixed food waste
020702	wastes from spirits distillation	complete	W091	Animal and mixed food waste
020704	materials unsuitable for consumption or processing	complete	W091	Animal and mixed food waste
200108	biodegradable kitchen and canteen waste	complete	W091	Animal and mixed food waste
200125	edible oil and fat	complete	W091	Animal and mixed food waste
200302	waste from markets	complete	W091	Animal and mixed food waste
200201	biodegradable waste	complete	W092	Vegetal wastes
200301	mixed municipal waste	pro rata	W101	Household and similar wastes

Notes

- The data for the waste stream biowaste is only available in aggregated form at the level of the EWC-Stat codes via Eurostat. In addition to primary waste from different areas of origin, these also include secondary waste that can be allocated to the waste stream, but which can no longer be directly allocated to the primary areas of origin.
- For the modelling of the waste stream biowaste, the EWC-Codes statistically recorded in the EWC-Stat group W091 – Animal and mixed food waste were considered (almost completely) (grey background).
- However, the total sum of EWC-Stat group W091 was adjusted by several EWC-Codes representing mainly cleaning sludges. Also, slurry was not considered.
- Further potentials were identified mainly in mixed municipal waste. Assumptions were made for the respective shares in municipal waste based on an average waste composition and assumptions on the quantities already statistically recorded in the EWC-Stat group.

Source: [Eurostat 2018], additional research and assessment by Prognos

Allocation of EWC-codes to waste streams

Waste derived fuels

EWC code		Share of EWC	EWC-Stat-code	
191210	combustible waste (refuse derived fuel)	complete	W103	Sorting residues
191212	other wastes (incl. mixtures of materials) from mechanical treatment of wastes other than those mentioned in 19 12 11	complete	W103	Sorting residues

Notes

- Waste derived fuels refers here to EWC-Code 191210 (combustible waste (RDF)) and 191212 (other waste) and, respectively, sorting losses from the selected material waste streams. These are not all high-calorific value WDF. The different qualities are modelled via the different treatment routes (e.g., cement kilns for WDF high calorific fractions).
- The EWC-Codes for burnable waste fractions summarized within this study as waste derived fuels (WDF) are part of the EWC-Stat group W103 – sorting residues.
- Assumptions were made for the respective shares based on literature review, analysis of additional statistics and interviews.

Source: [Eurostat 2018], additional research and assessment by Prognos

Allocation of EWC-codes to waste streams

Residual waste (non-separately collected waste and rejects from waste treatment)

EWC code		Share of EWC	EWC-Stat-code	
030307	mechanically separated rejects from pulping of waste paper and cardboard	complete	W103	Sorting residues
030308	wastes from sorting of paper and cardboard destined for recycling	complete	W103	Sorting residues
190501	non-composted fraction of municipal and similar wastes	complete	W103	Sorting residues
190502	non-composted fraction of animal and vegetable waste	complete	W103	Sorting residues
190503	off-specification compost	complete	W103	Sorting residues
190599	wastes not otherwise specified	complete	W103	Sorting residues
190801	screenings	complete	W103	Sorting residues
191003*	fluff-light fraction and dust containing dangerous substances	complete	W103	Sorting residues
191004	fluff-light fraction and dust other than those mentioned in 19 10 03	complete	W103	Sorting residues
191005*	other fractions containing dangerous substances	complete	W103	Sorting residues
191006	other fractions other than those mentioned in 19 10 05	complete	W103	Sorting residues
191211*	other wastes (incl. mixtures of materials) from mechanical treatment of waste containing dangerous substances	complete	W103	Sorting residues
200301	mixed municipal waste	pro rata	W101	Household and similar wastes
030310	fibre rejects, fibre-, filler- and coating-sludges from mechanical separation	complete	W072	Paper and cardboard wastes

Notes

- Rejects from waste treatment are statistically recorded in EWC-Stat group W103 – sorting residues. As the two burnable fractions 19 12 10 and 19 12 12 were considered separately, both EWC codes have been reduced here.
- Additionally, the fibre rejects, fibre-, filler- and coating-sludges from mechanical separation were considered.
- Also mixed municipal waste landfilled and/or thermally treated was allocated to the broader waste stream “residual waste”. It is acknowledged that in instances countries may over-report the same waste, once as under sorting residues and once under mixed municipal waste. Any such inconsistencies could not be addressed within this study.
- Additional recycling losses are added in the projections.
- For residual waste/WDF the EWC-Stat group W103 was, thus, completely recorded. (grey background).

*indicates hazardous waste

Source: [Eurostat 2018], additional research and assessment by Prognos

Annex A2

CO₂ Factors: Sources and Explanations

Incineration in a waste-to-energy (WtE) plant

Lower heating values and source for the incineration emissions per material/waste stream

Material/waste stream	LHV (GJ/ton)	Source; name of dataset
Paper and cardboard	15.9	Ecoinvent; Waste paperboard {RoW} treatment of, municipal incineration
Glass	0.0046	Ecoinvent; Waste glass {RoW} treatment of waste glass, municipal incineration
Plastics - PET	22.95	Ecoinvent; Waste polyethylene terephthalate {RoW} treatment of waste polyethylene terephthalate, municipal incineration
Plastics - PP (also bio-PP)	32.8	Ecoinvent; Waste polyethylene terephthalate {RoW} treatment of waste polyethylene terephthalate, municipal incineration
Plastics - LDPE	42.5	Ecoinvent; Waste polyethylene {RoW} treatment of waste polyethylene, municipal incineration
Plastics - HDPE	42.5	Ecoinvent; Waste polyethylene {RoW} treatment of waste polyethylene, municipal incineration
Plastics - PVC	21.5	Ecoinvent; Waste polyvinylchloride {RoW} treatment of waste polyvinylchloride, municipal incineration
Plastics - PS	38.7	Ecoinvent; Waste polystyrene {RoW} treatment of waste polystyrene, municipal incineration
Steel	0	Ecoinvent; Scrap steel {RoW} treatment of scrap steel, municipal incineration
Aluminium	0	Ecoinvent; Scrap aluminium {RoW} treatment of scrap aluminium, municipal incineration
Wood	14	Ecoinvent; Waste wood, untreated {RoW} treatment of waste wood, untreated, municipal incineration
Textile	14.5	Ecoinvent; Waste textile, soiled {RoW} treatment of, municipal incineration
Tyres	26	[Merlin & Vogt 2020], based on composition by [Schmidt et al., 2009]
Biowaste - GFT	4.3	Ecoinvent; Biowaste {GLO} treatment of biowaste, municipal incineration
Waste derived fuel	20.5	N+P Subcoal. Mix of paper and plastics

Source: analysis by CE Delft based on data sources mentioned

Notes

Incineration emissions are based on datasets from the Ecoinvent database (v.3.6). Transport is removed from these datasets and replaced by the generic transport scenario. The Ecoinvent datasets on incineration include upstream activities such as fuel consumption for operations (waste feed, scrubbers), use of auxiliary materials for flue gas purification (NaOH, quicklime), and downstream activities as final disposal of bottom ash and slag.

For plastics and the plastic part of textiles, which lead to CO₂ emission when incinerated, the contribution of these activities to the CO₂ factor is small (~1%). For inert and biobased materials that do not emit fossil CO₂ when combusted, the (relatively small) CO₂ factor is determined by these activities.

The CO₂ benefits of avoided heat and power are determined by three parameters:

- The lower heating value of the incinerated material
- The EU average net electrical and thermal efficiencies of EU WtE plants was provided by CEWEP.
- The type of energy that is substituted: electricity EU and heat (generated by multiple sources, EU average).

Incineration in a waste-to-energy (WtE) plant

Average municipal solid waste (MSW)

- The CO₂ factor of average municipal solid waste is based on the (calculated) average composition of the MSW, and the respective CO₂ factors per waste stream to a WtE plant.

Material type	Share within MSW	
	Baseline 2020	Projection 2035
Paper	11,5%	9,5%
Glass	4,7%	3,8%
Plastic	13,6%	13,2%
Ferrous metals - incl. recovery	2,5%	1,5%
Aluminium	0,5%	0,3%
Wood	2,3%	3,3%
Textiles	3,7%	4,0%
Biowaste	33,0%	32,3%
Other	28,1%	32,1%

- An additional CO₂ factor for the category 'Other' is determined indicatively, based on assuming the following components, each having an equal share in weight (1/5th)

Component within 'other'	LHV (GJ/ton)	Approximated in the model with (Source; name of dataset)
WEEE - Metals within appliances	0	Scrap copper {CH} treatment of, municipal incineration
Fine fraction, sediments, sludge	0	Raw sewage sludge {CH} treatment of, municipal incineration
Minerals, stony materials, inert materials	0	Waste cement-fibre slab, dismantled {CH} treatment of waste cement-fibre slab, municipal incineration
Plastics from electric and electronic appliances and from hygienic waste/diapers	30,8	Waste plastic, mixture {CH} treatment of, municipal incineration
Biowaste and filler material from hygienic/diapers	7	Biowaste {GLO} treatment of biowaste, municipal incineration

Source: analysis by CE Delft based on data sources mentioned

Incineration in a waste-to-energy (WtE) plant

EU average net electrical and thermal efficiencies

EU average net electrical and thermal efficiencies of EU WtE plant

- CEWEP [2021] has provided data on net EU efficiencies for electricity and heat from WtE plants for this study:
 - Net export electrical efficiency: 15%
 - Net export thermal efficiency: 32%
- The net efficiencies are based on:
 - A representative sample of WtE plants in the EU in terms of age and type: heat only plants, electricity only plants, and combined heat and power plants.
 - Actual reported electricity and heat, representing the average operating status per plant.
 - Weighting according to capacity.
- The average net efficiencies do not represent a specific WtE plant, but they are representative of the overall EU WtE fleet.
 - There are differences in the operating range of a plant depending on the location and the seasonality. For instance: in Nordic countries WtE facilities are typically more oriented towards heat production, whereas in warmer countries WtE facilities are more oriented towards electricity production.
 - In this study, when calculating CO₂ factors for incineration, the same efficiencies were applied to all materials/waste streams.
- CEWEP also provided an outlook for Projection 2. Higher net efficiencies for both heat and power recovery were predicted, based on the assumption that older plants will be substituted by more efficient facilities, typically as CHP plants that will gradually also become more predominant in Europe in the future.
- The estimated future average net EU efficiencies for electricity and heat from WtE plants, calculated for this study by CEWEP [2021], are:
 - Net export electrical efficiency: 20.4%
 - Net export thermal efficiency: 43.3%

Source: analysis by CE Delft based on data sources mentioned

Average EU electricity and heat mix – current and future (projection)

Average EU electricity mix

- The electricity mix is relevant for waste treatment processes, production of primary material (being avoided through recycling), and avoided electricity by incineration in WtE plants.

Electricity mix EU	kg CO _{2eq} /kWh 20y perspective	kg CO _{2eq} /kWh 100y perspective	Source; name of dataset
Current*	0,453	0.415	Ecoinvent v.3.6; Electricity, medium voltage (RER) market group for
Future	0,15	0.15	[EC 2020) CO ₂ factor based on: - Total electricity consumption, Projection 2030: 3100 TWh (p.58) - Total CO ₂ emissions in 2030 for this consumption this amount, based on prognosis of electricity mix composition in 2030: 464,7 Mt.
Marginal – current	0,977	0,870	Ecoinvent EU electricity mix, adjusted: excl. renewables, nuclear; fossil shares extrapolated
Marginal - future	0,715	0,626	Electricity from natural gas only

* The EEA provides a CO₂ factor of electricity as well, which is considerably lower (231 g CO_{2eq}/kWh for EU27, 100y perspective), because:

- EEA source does not include upstream life cycle emissions (mining, fuel production).
- Renewables and nuclear power therefore have a zero emission
- EEA does not include upstream transmission losses from high to medium voltage.

Source: analysis by CE Delft based on data sources mentioned

Average EU heat mix

- The heat mix is relevant for our specific models for avoided electricity by incineration in WtE plants. The source shows that the heat mix is expected to change only slightly, as the heat sector is harder to decarbonize than the electricity sector. Therefore, it was decided not to distinguish a future CO₂ factor.

Electricity mix EU	kg CO _{2eq} /MJ 20y perspective	kg CO _{2eq} /MJ 100y perspective	Source; name of dataset
Current and future	0,0656	0.0596	[EC 2016]
Marginal – current and future	0,106	0,0965	Fossil shares from above source extrapolated

Marginal EU electricity and heat mix – current and future (projection)

Marginal EU electricity mix

Fossil power source	Share		Source; name of dataset	Additional information
	Baseline scenario	Projection 2		
Natural gas	54.4% (extrapolated)	100%	Electricity, high voltage; electricity production, natural gas	For all power sources, multiple Ecoinvent datasets are available: for most EU Member States datasets are available per power source and sometimes for more than one technique. Per power source, an unweighted average of all the available datasets was created.
Coal + lignite	17.0% + 19.5% (extrapolated)		Electricity, high voltage; electricity production, hard coal	
Other fossil	9.0% (extrapolated)		Electricity, high voltage; electricity production, oil	

Notes

- As a sensitivity assessment, results were calculated with CO₂ factors that represent a marginal approach for avoided electricity and heat from WtE plants. A marginal approach is the case when the energy generated at WtE plants avoids the most carbon intensive conventional power generation technologies – fossil fuel sources – instead of the average electricity and heat mix (that also contains renewable energy). Adopting the average mix as default for energy substitution in this study, hence fits with a conservative approach.
- The share per power source in Europe is provided in [Agora & Sandbag 2020]
- The renewable share (34.6%) plus the nuclear share (25.5%), so combined 60.1%, was used to extrapolate each share per power source to resemble a 100% fossil mix.
- For the future marginal electricity mix, it was assumed that the most CO₂ intensive sources – oil, coal and lignite – will be phased out.
- The model is thus set-up representing the high voltage electricity. Next, a medium voltage dataset for marginal electricity mix is constructed by applying transmission losses and SF6 emission, as from the Ecoinvent datasets for medium voltage electricity.

Source: analysis by CE Delft based on data sources mentioned

Marginal EU electricity and heat mix – current and future (projection)

Marginal EU heat mix

- As a sensitivity assessment, results are calculated with CO₂ factors that represent a marginal approach for avoided electricity and heat from WtE plants. A marginal approach is the case when the energy generated at WtE plants avoids the most carbon intensive conventional power generation technologies – fossil fuel sources – instead of the average electricity and heat mix (that also contains renewable energy). Adopting the average mix as default for energy substitution in this study, hence fits with a conservative approach.
- The share per heat source in Europe is provided by EC [2016].
- The marginal EU heat mix is based on the shares of fossil heat sources extrapolated with the share of renewable heat (27%).
- The future heat mix is expected to change only slightly, as the heat sector is facing a greater challenge to be decarbonized than the electricity sector. Therefore, the shares are kept the same for all three scenarios.
- The following shares are used within this study:

Fossil power source for heat, marginal approach	Baseline & Projection 1	Projection 2
Natural gas	57.5%	57.5%
Coal	2.7%	2.7%
Fuel oil	21.9%	21.9%
Electric	17.8%	17.8%

Source: analysis by CE Delft based on data sources mentioned

Co-incineration in a coal-fired plant and in a cement kiln

Emissions

- The incineration emissions are specific to the waste stream being incinerated. The CO₂ emitted at incineration is the same as for incineration in a WtE plant. See the table under section 'Incineration in a waste-to-energy (WtE) plant'

Avoided Emissions

- Co-incineration in a cement kiln avoids the use of fossil energy sources as an energy source, mainly coal and lignite and a small share of fuel oil (<2%) [Merlin & Vogt 2020]. The substitution is based on:
 - The lower heating value of the material (see the LHVs under 'Incineration in a waste-to-energy (WtE) plant')
 - Information on the CO₂ emission per GJ coal incinerated in a furnace: 89,8 kg CO_{2eq}/GJ coal. Source: List of emission factors per energy carrier [RVO 2020].
- Incineration in a coal-fired power plant avoids the use of coal, based on the lower heating value of the waste.
 - The lower heating value of the material (see the LHVs under 'Incineration in a waste-to-energy (WtE) plant')
 - Information on the CO₂ emission per GJ coal incinerated in a furnace: 89,8 kg CO_{2eq}/GJ coal. Source: List of emission factors per energy carrier [RVO 2020].
- The reasoning behind the approach – substituting coal, based on energy content – is consequential reasoning:
 - if waste is not co-incinerated in a coal-fired power plant, more coal would have been used in the power plant. So coal is avoided (on an energy basis (LHV))
 - if waste is not co-incinerated in a cement kiln, more coal/lignite would have been used in the cement kiln. So coal is avoided (on an energy basis (LHV))

- This approach differs from incineration in a WtE plant, because in a WtE plant the consequential reasoning is as follows:
 - If waste is not incinerated in a WtE plant, more electricity and heat are generated from conventional sources for heat and electricity.
- One CO₂ factor is established for co-incineration. The distribution assumed in this study is:

Co-incineration route	Baseline + Projection 1	Projection 2
Coal fired plants	50%	10%
Cement kilns	50%	90%

Source: analysis by CE Delft based on data sources mentioned

Waste derived fuel, average municipal solid waste, wood incineration in bio-energy plants

Waste derived fuel (WDF)

- Waste derived fuel (WDF), sometimes referred to as refuse derived fuel or solid recovered fuel, is a fuel that is produced from a mixed waste stream such as from municipal solid waste or residual fractions from sorting and recycling processes.
- WDF is processed mostly in waste-to-energy plants but is partly also co-incinerated in coal-fired plants or cement kilns. Based on the estimated available national plant capacities of WtE and co-incineration, the thermally treated residual waste and WDF were allocated. Across the EU this results in an average split of around 75% to WtE and 25% to co-incineration. When the composition is unknown, the study works with an average composition of WDF, as provided by the company N+P. Also, this company supplied information about the recovery and production of WDF pellets.

Municipal solid waste (MSW)

- Municipal solid waste is a heterogenous mix of materials, which gets landfilled or incinerated in a WtE plant. When the composition is unknown, the study works with an average composition of MSW from the Ecoinvent database. The datasets used for landfilling and (the emissions of) incineration are:
 - Municipal solid waste {RoW} | treatment of, incineration
 - Municipal solid waste {CH} | treatment of, sanitary landfill
- Like with all datasets, the transport within this dataset is substituted by the default transport scenario for this study.

Wood in bio-energy plants

- In specialized bio-energy plants, wood is incinerated to generate heat and/or power. Prior to incineration, wood may be dried and pelletized. This step is included in the CO₂ factor.
- CE Delft inventoried the emissions and the thermal & electrical efficiency of four bio-energy plants in the Netherlands. The four models are used to create an unweighted average of wood to bio-energy plants. Due to confidentiality, the details will not be reported here.

Source: analysis by CE Delft based on data sources mentioned

Landfilling of waste streams

Landfilling

- The impact of landfilling is based on Ecoinvent inventories of materials 'to sanitary landfill'. These Ecoinvent inventories include methane capture, if relevant for the waste stream. The average methane recovery rate in the datasets is 53%. The datasets, therefore, include the net methane emission.
- The CO₂ factor for average MSW by Ecoinvent database is compared with a study on methane emissions of MSW landfilling (Wang et al., 2019). This study shows a range in CO₂ emission factors for three methane capturing techniques (passive venting, flaring and energy recovery). The Ecoinvent models represent the average of the several existing techniques. The CO₂ factors (20-year and 100-year time horizon) based on Ecoinvent were found to fall exactly within the range for the flaring technique as reported by Wang et al. The passive venting has a (much) higher CO₂ factor whereas the Energy Recovery/other thermal treatment has a lower CO₂ factor. The Ecoinvent models are therefore considered to be representative.
- No credit is included for the share of landfill gas energy recovery treatment, which additionally avoids fossil CO₂ from conventional energy sources. The percentage of landfills that on average utilize the landfill biogas (energy recovery) is not known, but is assumed to be small (Interreg/Cocoon 2018). Although this leads to a slight overestimation of the CO₂ factors, they are still falling within the (uncertainty) range by Wang et al. The avoided methane emission has the most significant effect on the CO₂-equivalence factor.
- For waste tyres a landfill ban is in place since 2003/2006, therefore no CO₂ factor for landfilling of tyres is included.
- The current legislation scenario refers in this study to the waste treatment route targets. The requirements of the EU Landfill Directive to extract landfill gas for energy use is not considered. On the one hand, this allows for better comparability against the baseline. On the other hand, only limited data was available for its calculation. The model considered an average methane recovery rate of 53% as provided by the available datasets. The datasets, therefore, include the net methane emission.

Source: analysis by CE Delft based on data sources mentioned

Mechanical recycling

Mechanical Recycling - general

- The CO₂ factors of recycling are calculated per tonne of sorted material. Existing life cycle inventories are used, which include sorting of the material from the (separately collected) waste, possible pre-treatment steps and the actual recycling process of the material. These life cycle inventories are, if necessary, adjusted to match the system boundaries as previously described. Transportation is substituted with the default transportation scenario for this study. The mass balance accounts for losses of target material during sorting and recycling processes.
- For Projection 2, the models of recycling are adjusted as follows: electricity consumption is based on the average EU mix for 2030, both for the recycling processes as for the production for (avoided) primary materials.
- In the coming sections, the sources for the recycling processes and the avoided materials are reported.

Recycling of paper and cardboard

- After a sorting step, paper and cardboard is sorted and then recycled in an integrated pulp and paper production facility. The end-product is often fluting medium or linerboard from recycled fibers. The Ecoinvent database does not contain information on recycled pulp fibers, hence the end-product is selected to represent the full process.

	Source; name of dataset	Additional comments, explanation
Recycling process(es)	Containerboard, fluting medium {RER} containerboard production, fluting medium, recycled	As explained under 'system boundaries', recycling of removed metals and co-incineration of the high caloric residues (plastics and paper) are not removed from the model (and thus not part the CO ₂ figure) of paper & cardboard recycling. In the study, the treatment of these fractions are determined with the CO ₂ factors for metal recycling and WDF co-incineration. Mass balance is accounted for.
Primary material production (avoided)	Containerboard, fluting medium {RER} containerboard production, fluting medium, semichemical	Mass balance is accounted for.

Source: analysis by CE Delft based on data sources mentioned

Mechanical recycling

Recycling of glass

	Source; name of dataset	Additional comments, explanation
Recycling process(es)	Ecoinvent; Glass cullet, sorted {RER} treatment of waste glass from unsorted public collection, sorting	Represents sorting and recycling of glass cullets. Mass balance is accounted for.
Primary material production (avoided)	Packaging glass, white {GLO} packaging glass production, white, without cullet	Adjusted: avoided raw materials only. Energy for glass manufacturing excluded. Mass balance is accounted for.

Recycling of wood

- Applicable to recycling of clean, separately collected wood, which is treated into wood chips for multiple purposes, such as use in particle board.

	Source; name of dataset	Additional explanation	comments,
Recycling process(es)	Ecoinvent; Wood chipping, industrial residual wood, stationary electric chipper {RER} processing		
Primary material production (avoided)	50%: Wood chips, wet, measured as dry mass, wood chips production, hardwood, at sawmill 50%: Wood chips, wet, measured as dry mass, wood chips production, softwood, at sawmill	Adjusted with the average EU electricity mix	

Source: analysis by CE Delft based on data sources mentioned

Mechanical recycling

Recycling of plastics

	Source; name of dataset	Additional comments, explanation
Sorting of combined collected plastics	Inventory of electricity consumption and mass balance of three sorting facilities for mixed plastics / plastics from MSW	
Sorting of separately collected PET bottles	Inventory of electricity consumption and mass balance of main collecting/sorting company for PET bottles.	
Recycling process(es)	Inventory of energy consumption, auxiliary materials and mass balance for: <ul style="list-style-type: none"> ▪ PET bottle recycling ▪ PET trays recycling ▪ PP recycling ▪ HDPE recycling ▪ LDPE foil recycling ▪ Mixed plastics recycling 	Based on data by >15 companies that recycle the so-called 'DKR-streams': DKR provides standardization of quality of sorted streams. The inventory details are most often confidential company information and are therefore not reported.
Primary material production (avoided)	<ul style="list-style-type: none"> ▪ PET: Polyethylene terephthalate, granulate, amorphous (RER) production ▪ PP: Polypropylene, granulate (RER) production ▪ HDPE: Polyethylene, high density, granulate (RER) production ▪ LDPE foil: Polyethylene, low density, granulate (RER) production ▪ Mixed plastics: see comments 	If the mixed plastic fraction is recycled, it is recycled into solid product like marker posts or shelves for outdoor public benches. These products avoid a mix of materials; wood, concrete, coated steel and primary plastics (assumption: ¼ each).

Source: analysis by CE Delft based on data sources mentioned

Notes

- Plastics may become available for recycling via several collection schemes. PET bottles are often collected as a separate stream. Combined plastic, collected plastics, or plastics recovered from municipal solid waste, are sorted into mono-streams for several bulk plastic types – PET, PP, HDPE and LDPE foils – and a mixed fraction. The sorted fractions are then transported to dedicated recycling facilities. After pretreatment – consisting of several steps like further sorting, chipping, washing, drying to remove all unwanted pollutants/non-plastics – the plastics are optionally recycled via melting and extrusion. The resulting recycled product is either flakes or granulates. The recycled flakes and granulates replace primary plastic granulates.
- For the CO₂ factors an extensive inventory by CE Delft is used, of the Dutch plastic recycling system for plastics from households and offices. The inventory and model was first constructed in 2012 and updated over the years (latest: 2020). It covers the abovementioned plastics: CO₂ factors can be determined per plastic type. Also, a weighted average CO₂ factor could be determined, based on the amount of plastics in the Dutch waste system (year 2015), per plastic type and per waste treatment route, and the treated volumes of plastics at sorters and recyclers.
- The models for plastics recycling were adjusted with the transport scenario for this study, and with the EU electricity mix for recycling processes and for production of the avoided primary plastics. Also, the model was adjusted according to the system boundaries applied in this study. (see also [CE Delft 2021], [CE Delft 2011])

Mechanical recycling - materials

Recycling of plastic: PVC

- PVC from non-packaging applications, such as construction products (window frames, pipes) may be separately collected and recycled at dedicated recycling companies. Inventory data from an existing LCA study was used to model PVD recycling: [Stichnoth & Azapagica; 2012] "Life cycle assessment of recycling PVC window frames".

	Source; name of dataset	Additional explanation	comments,
Recycling process(es)	Electricity and diesel consumption and mass balance according to Stichnoth & Azapagica; 2012.	EU electricity mix.	
Primary material production (avoided)	Ecoinvent; Polyvinylchloride, suspension polymerised {RER} polyvinylchloride production, suspension polymerisation		

Recycling of textiles

- Mechanical recycling of textiles focusses on deconstructing the fabric into fibres, which can be spun into yarn. Prior to this recycling step, add-ons like buttons and zippers are removed from the (separately collected) textile products. Part of the textile fabric is lost during the pre-treatment process (fabric attached to the add-ons) and recycling processes (fibres that have become too short for re-spinning). The reclaimed fibres avoid the production of primary fibres.

	Source; name of dataset	Additional comments, explanation
Recycling process(es)	Electricity pretreatment recycling Manual sorting.	for and Source: inventory data by a Dutch recycler. EU electricity mix used for the model.
Primary material production (avoided)	27% Cotton fibre {RoW} cotton production 63%: Fibre, polyester {RoW} polyester fibre production	Cotton and polyester represent over 75% of all fibre materials for textiles. The distribution between cotton (27%) and polyester (63%) is based on [Textile Exchange, 2020]; 'Preferred Fiber Material Market Report 2019'. Available from: textileexchange.org Cotton represents the biobased fibres; polyester represents the synthetic fibres.

Source: analysis by CE Delft based on data sources mentioned

Mechanical recycling - materials

Recycling of steel

Mechanically recovered steel	Source; name of dataset	Additional comments, explanation
Recycling process(es)	World steel association: Steel production Europe, electric arc furnace	World steel offers LCA results for specific regions and specific steel products upon request. For this study, data for average EU steelmaking (secondary and primary) was requested and received.
Primary material production (avoided)	World steel association: Steel production Europe, blast oxygen furnace	
Steel recovery from bottom ash	Source; name of dataset	Additional comments, explanation
Recovery process	Incineration of steel: Ecoinvent: Scrap steel {Europe without Switzerland} treatment of scrap steel, municipal incineration Recovery process: electricity and diesel consumption	Source for the recovery process: CE Delft, 2019; 'Treatment routes of Flemish waste from households and companies 2020-2030' (in Dutch). Recovery rate: 96%
Recycling process(es)	World steel association: Steel production Europe, electric arc furnace	World steel offers LCA results for specific regions and specific steel products upon request. For this study, data for average EU steelmaking (secondary and primary) was requested and received.
Primary material production (avoided)	World steel association: Steel production Europe, blast oxygen furnace	

Source: analysis by CE Delft based on data sources mentioned

Notes

- Steel can be recovered for recycling in different ways, such as separately collected (cans), removed magnetically from municipal solid waste fraction prior to incineration or landfilling, removed steel from other (separately) collected waste streams, and recovered from incinerator bottom ashes.
- The recovered steel is recycled in electric arc furnaces into secondary intermediate steel products. This avoids the production of intermediate steel product ('pig iron') from primary sources.
- A separate CO₂ factor is provided for the recovery of steel from bottom ash, as the recovery process and mass balance differs from the other recycling routes.

Mechanical recycling - materials

Recycling of aluminium

Mechanically recovered aluminium	Source; name of dataset	Additional comments, explanation
Recycling process(es)	Ecoinvent: Aluminium, cast alloy {RER} treatment of aluminium scrap, post-consumer, prepared for recycling, at refinery	Adjusted to represent system boundaries (transport, waste treatment).
Primary material production (avoided)	Ecoinvent: Aluminium, primary, ingot {IA Area, EU27 & EFTA} market for	

Aluminium recovery from bottom ash	Source; name of dataset	Additional comments, explanation
Recovery process	Incineration of steel: Scrap aluminium {Europe without Switzerland} treatment of scrap aluminium, municipal incineration Recovery process: electricity and diesel consumption	Source for the recovery process: CE Delft, 2019; 'Treatment routes of Flemish waste from households and companies 2020-2030' (in Dutch). Recovery rate: 72%
Recycling process(es)	Ecoinvent: Aluminium, cast alloy {RER} treatment of aluminium scrap, post-consumer, prepared for recycling, at refinery	Adjusted to represent system boundaries (transport, waste treatment).
Primary material production (avoided)	Ecoinvent: Aluminium, primary, ingot {IA Area, EU27 & EFTA} market for	

Source: analysis by CE Delft based on data sources mentioned

Notes

- Like steel, aluminium can be recovered for recycling in different ways, such as separately collected, recovered from the municipal waste fraction by means of eddy currents prior to incineration or landfilling, removed from other (separately) collected waste streams, and recovered from incinerator bottom ashes.
- The recovered aluminium is prepared for recycling and added to smelters which also process primary aluminium ingots. The aluminium prepared for recycling avoids the production of primary aluminium ingots.
- A separate CO₂ factor is provided for the recovery of aluminium from bottom ash, as the recovery process and mass balance differs from the other recycling routes.

Mechanical recycling - materials

Recycling of biowaste

Inventoried aspect	Source; name of dataset	Additional comments, explanation
Input: energy (electricity and heat) and auxiliary substances for fermentation and composting processes	[Stichting RIONED & STOWA 2015]	
Emissions from composting and fermentation	[UBA 2015].	
Output: the produced amounts of compost, biogas, electricity and heat, per tonne input	[Rijkswaterstaat 2020]	<p>This source provides a link between the total annual input of biowaste and output (amounts) of compost, biogas, electricity and heat. 30% of the biowaste was treated in anaerobic digestion plants (including post-composting of the residues), 70% was treated in composting facilities.</p> <ul style="list-style-type: none"> Compost avoids the use of fertilizer and peat. The shares are determined based on actual application as potting compost (avoiding peat) and in agri-/horticulture (avoiding fertilizer). Biogas avoids the use of conventional natural gas. Electricity and heat avoid the use of conventional electricity and heat. <p>The information from [Rijkswaterstaat, 2020] is based on 21 facilities, of which 11 anaerobic digestion facilities with post-composting of residues and 10 composting only facilities.</p>
Carbon sink: compost stores carbon (C) in the ground.	[CE Delft 2020]	

Source: analysis by CE Delft based on data sources mentioned

Notes

- Separately collected biowaste can be composted, fermented in anaerobic digestion plants, or as a combination: first fermented and the residual fraction composted. When done in specialized facilities, fermentation produces biogas, electricity and heat; composting produces compost. Biogas substitutes conventional gas, electricity and heat; compost avoids the use of peat and fertilizer.
- The inventory of the composting and fermentation of biowaste includes several aspects. This approach was developed in the study CE Delft [CE Delft 2020]

Mechanical recycling - materials

Recycling of tyres

- The recycling of tyres is taken from the study from [Merlin & Vogt 2020] . It contains LCA results for two recycling routes, which are adopted for this study:
 - Mechanical recycling. This produces two recycled fractions: rubber granulates, avoiding EPDM and SEBS infills, and steel. The results are applied to the Baseline scenario and Projection 1.
 - Cryogenic recycling. The rubber granulates are further treated (cryogenic) and replace carbon black and synthetic rubber. The results are applied to the Baseline scenario and Projection 2.
- [Merlin & Vogt 2020] contains the following disclaimer: “Some of the assumptions as well as the scenario definitions affect the results, interpretation and conclusions of the study. Therefore, it is of utmost importance that these and their influence on the results and conclusions are described transparently to avoid any potential misinterpretation of the study. A critical review statement is available upon request.”
- For details, such as the composition of tyres and description of the recycling processes, see [Merlin & Vogt 2020].

Source: analysis by CE Delft based on data sources mentioned

Annex A3

CO₂ Factors per Scenario

CO₂ factors: IPCC – 20-years Baseline scenario, Projection 1 & 2 excl. transport (1/3)

Material/waste stream	Waste treatment route	Baseline + Projection 1			Projection 2		
		Emissions per tonne of material (kg CO ₂ eq)	Avoided emissions per tonne of material (kg CO ₂ eq)	Net result (kg CO ₂ eq)	Emissions per tonne of material (kg CO ₂ eq)	Avoided emissions per tonne of material (kg CO ₂ eq)	Net result (kg CO ₂ eq)
Paper and cardboard	Incineration with energy recovery in WtE plant (MSWI) - excl. biogenic CO ₂	25	-635	-610	25	-587	-562
	Co-incineration in a coal-fired plant / cement kiln* - excl. biogenic CO ₂	25	-1810	-1785	25	-1810	-1785
	Recycling to fluting medium - based on Ecoinvent recycled paper, avoiding primary fluting medium	607	-547	60	568	-471	97
	Landfill	4477	0	4477	4477	0	4477
Glass	Incineration with energy recovery in WtE plant (MSWI)	14	-2	12	35	-2	33
	Recycling	15	-212	-197	14	-212	-198
	Landfill	10	0	10	10	0	10
Plastics - PET bottles	Incineration with energy recovery in WtE plant (MSWI)	2029	-915	1114	2029	-847	1182
	Co-incineration in a coal-fired plant / cement kiln*	2029	-2613	-584	2029	-2613	-584
	Recycling - mechanical	413	-2495	-2081	354	-2464	-2110
	Landfill	205	0	205	205	0	205
Plastics - PET trays and other non-bottle products	Incineration with energy recovery in WtE plant (MSWI)	2029	-915	1114	2029	-847	1182
	Co-incineration in a coal-fired plant / cement kiln*	2029	-2613	-584	2029	-2613	-584
	Recycling - mechanical	614	-1194	-580	595	-1194	-599
	Landfill	205	0	205	205	0	205
Plastics - PP	Incineration with energy recovery in WtE plant (MSWI)	2533	-1307	1226	2533	-1209	1324
	Co-incineration in a coal-fired plant / cement kiln*	2533	-3732	-1199	2533	-3732	-1199
	Recycling - mechanical	401	-2011	-1610	277	-1943	-1667
	Landfill	254	0	254	254	0	254
Plastics - LDPE	Incineration with energy recovery in WtE plant (MSWI)	2994	-1694	1300	2994	-1567	1427
	Co-incineration in a coal-fired plant / cement kiln*	2994	-4284	-1289	2994	-4835	-1841
	Recycling - mechanical	1244	-1680	-437	897	-1535	-637
	Landfill	300	0	300	300	0	300
Plastics - HDPE	Incineration with Energy Recovery treatment (MSWI)	2994	-1694	1300	2994	-1567	1427
	Co-incineration in a coal-fired plant / cement kiln*	2994	-4284	-1289	2994	-4835	-1841
	Recycling - mechanical	554	-1833	-1279	404	-1767	-1363
	Landfill	300	0	300	300	0	300

* Baseline + Projection 1: 50%/50%; Projection 2: 10%/90%; Avoiding coal on an energy basis

Source: [Ecoinvent v.3.6], assessment and calculation by CE Delft

CO₂ factors: IPCC – 20-years Baseline scenario, Projection 1 & 2 excl. transport (2/3)

Material/waste stream	Waste treatment route	Baseline + Projection 1			Projection 2		
		Emissions per tonne of material (kg CO ₂ eq)	Avoided emissions per tonne of material (kg CO ₂ eq)	Net result (kg CO ₂ eq)	Emissions per tonne of material (kg CO ₂ eq)	Avoided emissions per tonne of material (kg CO ₂ eq)	Net result (kg CO ₂ eq)
Plastics - PS	Incineration with energy recovery in WtE plant (MSWI)	1731	-1542	188	1731	-1427	304
	Landfill	316	0	316	316	0	316
Plastics - PVC	Incineration with energy recovery in WtE plant (MSWI)	1605	-858	747	1605	-794	811
	Recycling - mechanical. Applicable to PVC window frames and pipes, not to PVC packaging	304	-1639	-1335	84	-1639	-1555
	Landfill	165	0	165	165	0	165
Bioplastics	Incineration with energy recovery in WtE plant (MSWI)	23	-1194	-1171	23	-1194	-1171
	Incineration with energy recovery in WtE plant (MSWI), no metal recovery	11	0	11	26	0	26
Steel	Incineration with metal recovery from bottom ash (MSWI) and recycling in EAF	672	-1949	-1277	683	-1949	-1266
	Recycling of separately collected metals	678	-2030	-1352	678	-2030	-1352
	Landfill	6	0	6	6	0	6
Aluminium	Incineration with energy recovery in WtE plant (MSWI), no metal recovery	15	0	15	26	0	26
	Incineration with metal recovery from bottom ash (MSWI) and recycling in smelter	682	-7491	-6809	677	-7491	-6814
	Recycling of separately collected metals	910	-10368	-9457	892	-10368	-9475
	Landfill	15	0	15	17	0	17
Wood	Incineration with energy recovery in WtE plant (MSWI)	10	-554	-544	10	-513	-503
	Incineration in bio-energy facility	106	-721	-615	77	-291	-214
	Recycling to wood chips	10	-20	-11	3	-13	-10
	Landfill	203	0	203	203	0	203
Textile - cotton/polyester mix	Incineration with energy recovery in WtE plant (MSWI)	122	-578	-456	122	-535	-413
	Mechanical recycling of fibres	431	-3864	-3433	279	-3864	-3585
	Landfill	1422	0	1422	1422	0	1422

Source: [Ecoinvent v.3.6], assessment and calculation by CE Delft

CO₂ factors: IPCC – 20-years Baseline scenario, Projection 1 & 2 excl. transport (3/3)

Material/waste stream	Waste treatment route	Baseline + Projection 1			Projection 2		
		Emissions per tonne of material (kg CO ₂ eq)	Avoided emissions per tonne of material (kg CO ₂ eq)	Net result (kg CO ₂ eq)	Emissions per tonne of material (kg CO ₂ eq)	Avoided emissions per tonne of material (kg CO ₂ eq)	Net result (kg CO ₂ eq)
Tyres	Incineration with energy recovery in WtE plant (MSWI)	Not applicable			Not applicable		
	Co-incineration in a coal-fired plant / cement kiln*	1848	-2960	-1112	1848	-3062	-1214
	Mechanical recycling - replaces infills	Not available	Not available	-838	Not available	Not available	-838
	Cryogenic recycling - replaces synthetic rubber	Not available	Not available	-1.950	0	Not available	-1.950
	Landfill	Not applicable: ban since 2003/2006			Not applicable: ban since 2003/2006		
Biowaste - Swill	Incineration with energy recovery in WtE plant (MSWI)	39	-171	-133	39	-159	-120
	Average treatment. Combination of composting and fermentation + composting of residue	64	-195	-131	52	-179	-127
	Composting only - Approximation; likely underestimation	74	-99	-25	74	-99	-25
	Landfill	1846	0	1846	1846	0	1846
Waste derived fuel (WDF) based on paper and plastics	Co-incineration in a coal-fired plant / cement kiln*	1324	-2334	-1010	1324	-2334	-1010
Municipal solid waste, average, Baseline scenario	Incineration with energy recovery in WtE plant (MSWI)	489	-479	10	(see below)		
	Landfill	1801	0	1801	(see below)		
Municipal solid waste, average, Projection 1+2	Incineration with energy recovery in WtE plant (MSWI)	492	-459	33	493	-427	66
	Landfill	1801	0	1801	618	0	618

* Baseline + Projection 1: 50%/50%; Projection 2: 10%/90%; Avoiding coal on an energy basis

Source: [Ecoinvent v.3.6], assessment and calculation by CE Delft

CO₂ factors: IPCC – 20-years Baseline scenario, Projection 1 & 2

Marginal approach Energy Recovery/other thermal treatment excl. transport (1/3)

Material/waste stream	Waste treatment route	Baseline + Projection 1			Projection 2		
		Emissions per tonne of material (kg CO ₂ eq)	Avoided emissions per tonne of material (kg CO ₂ eq)	Net result (kg CO ₂ eq)	Emissions per tonne of material (kg CO ₂ eq)	Avoided emissions per tonne of material (kg CO ₂ eq)	Net result (kg CO ₂ eq)
Paper and cardboard	Incineration with energy recovery in WtE plant (MSWI)- excl. biogenic CO ₂	25	-1189	-1164	25	-1376	-1352
	Co-incineration in a coal-fired plant / cement kiln* - excl. biogenic CO ₂	25	-1810	-1785	25	-1810	-1785
	Recycling to fluting medium - based on Ecoinvent recycled paper, avoiding primary fluting medium	607	-547	60	568	-471	97
	Landfill	4477	0	4477	4477	0	4477
Glass	Incineration with energy recovery in WtE plant (MSWI)	14	-3	11	35	-4	31
	Recycling	15	-212	-197	14	-212	-198
	Landfill	10	0	10	10	0	10
Plastics - PET bottles	Incineration with energy recovery in WtE plant (MSWI)	2029	-1714	315	2029	-1984	45
	Co-incineration in a coal-fired plant / cement kiln*	2029	-2613	-584	2029	-2613	-584
	Recycling - mechanical	413	-2495	-2081	354	-2464	-2110
	Landfill	205	0	205	205	0	205
Plastics - PET trays and other non-bottle products	Incineration with energy recovery in WtE plant (MSWI)	2029	-1714	315	2029	-1984	45
	Co-incineration in a coal-fired plant / cement kiln*	2029	-2613	-584	2029	-2613	-584
	Recycling - mechanical	614	-1194	-580	595	-1194	-599
	Landfill	205	0	205	205	0	205
Plastics - PP	Incineration with energy recovery in WtE plant (MSWI)	2533	-2447	86	2533	-2834	-301
	Co-incineration in a coal-fired plant / cement kiln*	2533	-3732	-1199	2533	-3732	-1199
	Recycling - mechanical	401	-2011	-1610	277	-1943	-1667
	Landfill	254	0	254	254	0	254
Plastics - LDPE	Incineration with energy recovery in WtE plant (MSWI)	2994	-3171	-177	2994	-3672	-678
	Co-incineration in a coal-fired plant / cement kiln*	2994	-4284	-1289	2994	-4835	-1841
	Recycling - mechanical	1244	-1680	-437	897	-1535	-637
	Landfill	300	0	300	300	0	300
Plastics - HDPE	Incineration with energy recovery in WtE plant (MSWI)	2994	-3171	-177	2994	-3672	-678
	Co-incineration in a coal-fired plant / cement kiln*	2994	-4284	-1289	2994	-4835	-1841
	Recycling - mechanical	554	-1833	-1279	404	-1767	-1363
	Landfill	300	0	300	300	0	300

* Baseline + Projection 1: 50%/50%; Projection 2: 10%/90%; Avoiding coal on an energy basis

Source: [Ecoinvent v.3.6], assessment and calculation by CE Delft

CO₂ factors: IPCC – 20-years Baseline scenario, Projection 1 & 2

Marginal approach Energy Recovery/other thermal treatment excl. transport (2/3)

Material/waste stream	Waste treatment route	Baseline + Projection 1			Projection 2		
		Emissions per tonne of material (kg CO ₂ eq)	Avoided emissions per tonne of material (kg CO ₂ eq)	Net result (kg CO ₂ eq)	Emissions per tonne of material (kg CO ₂ eq)	Avoided emissions per tonne of material (kg CO ₂ eq)	Net result (kg CO ₂ eq)
Plastics - PS	Incineration with energy recovery in WtE plant (MSWI)	1731	-2887	-1157	1731	-3343	-1613
	Landfill	316	0	316	316	0	316
Plastics - PVC	Incineration with energy recovery in WtE plant (MSWI)	1605	-1606	-1	1605	-1860	-255
	Recycling - mechanical. Applicable to PVC window frames and pipes, not to PVC packaging	304	-1639	-1335	84	-1639	-1555
	Landfill	165	0	165	165	0	165
Bioplastics	Incineration with energy recovery in WtE plant (MSWI)	23	-2447	-2425	23	-2834	-2811
Steel	Incineration with energy recovery in WtE plant (MSWI), no metal recovery	11	0	11	26	0	26
	Incineration with metal recovery from bottom ash (MSWI) and recycling in EAF	672	-1949	-1277	683	-1949	-1266
	Recycling of separately collected metals	678	-2030	-1352	678	-2030	-1352
	Landfill	6	0	6	6	0	6
Aluminium	Incineration with energy recovery in WtE plant (MSWI), no metal recovery	15	0	15	26	0	26
	Incineration with metal recovery from bottom ash (MSWI) and recycling in smelter	682	-7491	-6809	677	-7491	-6814
	Recycling of separately collected metals	910	-10368	-9457	892	-10368	-9475
	Landfill	15	0	15	17	0	17
Wood	Incineration with energy recovery in WtE plant (MSWI)	10	-1038	-1028	10	-1202	-1192
	Incineration in bio-energy facility	106	-1511	-1405	77	-1139	-1063
	Recycling to wood chips	10	-20	-11	3	-13	-10
	Landfill	203	0	203	203	0	203
Textile - cotton/polyester mix	Incineration with energy recovery in WtE plant (MSWI)	122	-1083	-961	122	-1254	-1132
	Mechanical recycling of fibres	431	-3864	-3433	279	-3864	-3585
	Landfill	1422	0	1422	1422	0	1422

Source: [Ecoinvent v.3.6], assessment and calculation by CE Delft

CO₂ factors: IPCC – 20-years Baseline scenario, Projection 1 & 2

Marginal approach Energy Recovery/other thermal treatment excl. transport (3/3)

Material/waste stream	Waste treatment route	Baseline + Projection 1			Projection 2		
		Emissions per tonne of material (kg CO ₂ eq)	Avoided emissions per tonne of material (kg CO ₂ eq)	Net result (kg CO ₂ eq)	Emissions per tonne of material (kg CO ₂ eq)	Avoided emissions per tonne of material (kg CO ₂ eq)	Net result (kg CO ₂ eq)
Tyres	Incineration with energy recovery in WtE plant (MSWI)	Not applicable			Not applicable		
	Co-incineration in a coal-fired plant / cement kiln*	1848	-2960	-1112	1848	-2960	-1112
	Mechanical recycling - replaces infills	Not available	Not available	-838	Not available	Not available	-838
	Cryogenic recycling - replaces synthetic rubber	Not available	Not available	-1.950	0	Not available	-1.950
	Landfill	Not applicable: ban since 2003/2006			Not applicable: ban since 2003/2006		
Biowaste - Swill	Incineration with energy recovery in WtE plant (MSWI)	39	-2960	-1112	39	-296	-258
	Average treatment. Combination of composting and fermentation + composting of residue	64	-195	-131	52	-179	-127
	Composting only - Approximation; likely underestimation	74	-99	-25	74	-99	-25
	Landfill	1846	0	1846	1846	0	1846
Waste derived fuel (WDF) based on paper and plastics	Co-incineration in a coal-fired plant / cement kiln*	1324	-1531	-207	1324	-2334	-1010
Municipal solid waste, average, Baseline scenario	Incineration with energy recovery in WtE plant (MSWI)	489	-2334	-1010	(see below)		
	Landfill	1801	0	1801	(see below)		
Municipal solid waste, average, Projection 1+2	Incineration with energy recovery in WtE plant (MSWI)	492	-835	-343	493	-937	-445
	Landfill	1801	0	1801	618	0	618

* Baseline + Projection 1: 50%/50%; Projection 2: 10%/90%; Avoiding coal on an energy basis

Source: [Ecoinvent v.3.6], assessment and calculation by CE Delft

CO₂ factors: IPCC – 100-years Baseline scenario, Projection 1 & 2 excl. transport (1/3)

Material/waste stream	Waste treatment route	Baseline + Projection 1			Projection 2		
		Emissions per tonne of material (kg CO ₂ eq)	Avoided emissions per tonne of material (kg CO ₂ eq)	Net result (kg CO ₂ eq)	Emissions per tonne of material (kg CO ₂ eq)	Avoided emissions per tonne of material (kg CO ₂ eq)	Net result (kg CO ₂ eq)
Paper and cardboard	Incineration with energy recovery in WtE plant (MSWI)- excl. Biogenic CO ₂	22	-579	-557	22	-546	-524
	Co-incineration in a coal-fired plant / cement kiln* - excl. Biogenic CO ₂	22	-1624	-1602	22	-1624	-1602
	Recycling to fluting medium - based on Ecoinvent recycled paper, avoiding primary fluting medium	509	-483	26	475	-416	58
	Landfill	1510	0	1510	1511	0	1511
Glass	Incineration with energy recovery in WtE plant (MSWI)	12	-2	10	33	-2	31
	Recycling	9	-187	-177	8	-187	-178
	Landfill	9	0	9	9	0	9
Plastics - PET bottles	Incineration with energy recovery in WtE plant (MSWI)	2027	-835	1193	2027	-787	1240
	Co-incineration in a coal-fired plant / cement kiln*	2027	-2345	-317	2027	-2345	-317
	Recycling - mechanical	378	-2000	-1622	326	-1973	-1647
	Landfill	88	0	88	88	0	88
Plastics - PET trays and other non-bottle products	Incineration with energy recovery in WtE plant (MSWI)	2027	-835	1193	2027	-787	1240
	Co-incineration in a coal-fired plant / cement kiln*	2027	-2345	-317	2027	-2345	-317
	Recycling - mechanical	563	-965	-402	547	-965	-418
	Landfill	88	0	88	88	0	88
Plastics - PP	Incineration with energy recovery in WtE plant (MSWI)	2532	-1192	1339	2532	-1125	1407
	Co-incineration in a coal-fired plant / cement kiln*	2532	-3349	-817	2532	-3349	-817
	Recycling - mechanical	368	-1507	-1139	259	-1448	-1189
	Landfill	107	0	107	107	0	107
Plastics - LDPE	Incineration with energy recovery in WtE plant (MSWI)	2992	-1545	1448	2992	-1457	1536
	Co-incineration in a coal-fired plant / cement kiln*	2992	-3844	-851	2992	-4339	-1346
	Recycling - mechanical	1180	-1289	-109	877	-1161	-284
	Landfill	126	0	126	126	0	126
Plastics - HDPE	Incineration with energy recovery in WtE plant (MSWI)	2992	-1545	1448	2992	-1457	1536
	Co-incineration in a coal-fired plant / cement kiln*	2992	-3844	-851	2992	-4339	-1346
	Recycling - mechanical	507	-1409	-902	377	-1351	-975
	Landfill	126	0	126	126	0	126

Source: [Ecoinvent v.3.6], assessment and calculation by CE Delft

* Baseline + Projection 1: 50%/50%; Projection 2: 10%/90%; Avoiding coal on an energy basis

CO₂ factors: IPCC – 100-years Baseline scenario, Projection 1 & 2 excl. transport (2/3)

Material/waste stream	Waste treatment route	Baseline + Projection 1			Projection 2		
		Emissions per tonne of material (kg CO ₂ eq)	Avoided emissions per tonne of material (kg CO ₂ eq)	Net result (kg CO ₂ eq)	Emissions per tonne of material (kg CO ₂ eq)	Avoided emissions per tonne of material (kg CO ₂ eq)	Net result (kg CO ₂ eq)
Plastics - PS	Incineration with energy recovery in WtE plant (MSWI)	1859	-1407	452	1859	-1327	532
	Landfill	132	0	132	132	0	132
Plastics - PVC	Incineration with energy recovery in WtE plant (MSWI)	1589	-782	806	1589	-738	851
	Recycling - mechanical. Applicable to PVC window frames and pipes, not to PVC packaging	100	-1350	-1250	84	-1350	-1266
	Landfill	71		71	71		71
Bioplastics	Incineration with energy recovery in WtE plant (MSWI)	23	-1192	-1170	23	-1125	-1102
Steel	Incineration with energy recovery in WtE plant (MSWI), no metal recovery	10	0	10	25	0	25
	Incineration with metal recovery from bottom ash (MSWI) and recycling in EAF	670	-1949	-1279	682	-1949	-1267
	Recycling of separately collected metals	678	-2030	-1352	678	-2030	-1352
	Landfill	5	0	5	5	0	5
Aluminium	Incineration with energy recovery in WtE plant (MSWI), no metal recovery	14	0	14	24	0	24
	Incineration with metal recovery from bottom ash (MSWI) and recycling in smelter	624	-6990	-6367	620	-6990	-6370
	Recycling of separately collected metals	832	-9675	-8843	816	-9675	-8859
	Landfill	14	0	14	14	0	14
Wood	Incineration with energy recovery in WtE plant (MSWI)	9	-506	-497	9	-477	-468
	Incineration in bio-energy facility	95	-659	-565	69	-284	-214
	Recycling to wood chips	9	-18	-10	3	-12	-9
	Landfill	75	0	75	75	0	75
Textile - cotton/polyester mix	Incineration with energy recovery in WtE plant (MSWI)	117	-527	-411	117	-497	-381
	Mechanical recycling of fibres	306	-3200	-2895	173	-3200	-3027
	Landfill	484	0	484	484	0	484

Source: [Ecoinvent v.3.6], assessment and calculation by CE Delft

CO₂ factors: IPCC – 100-years Baseline scenario, Projection 1 & 2 excl. transport (3/3)

Material/waste stream	Waste treatment route	Baseline + Projection 1			Projection 2		
		Emissions per tonne of material (kg CO ₂ eq)	Avoided emissions per tonne of material (kg CO ₂ eq)	Net result (kg CO ₂ eq)	Emissions per tonne of material (kg CO ₂ eq)	Avoided emissions per tonne of material (kg CO ₂ eq)	Net result (kg CO ₂ eq)
Tyres	Incineration with energy recovery in WtE plant (MSWI)	Not applicable			Not applicable		
	Incineration in a coal-fired plant / cement kiln*	1848	-2656	-809	1848	-2728	-880
	Mechanical recycling - replaces infills	Not available	Not available	-838	Not available	Not available	-838
	Cryogenic recycling - replaces synthetic rubber	Not available	Not available	-1.950	0	Not available	-1.950
	Landfill	Not applicable: ban since 2003/2006			Not applicable: ban since 2003/2006		
Biowaste - Swill	Incineration with energy recovery in WtE plant (MSWI)	37	-156	-120	37	-148	-111
	Average treatment. Combination of composting and fermentation + composting of residue	37	-196	-159	26	-178	-152
	Composting only – approximation; likely underestimation	48	-99	-51	48	-99	-51
	Landfill	620	0	620	620	0	620
Waste derived fuel (WDF) based on paper and plastics	Incineration in a coal-fired plant / cement kiln*	1298	-2094	-797	1298	-2094	-797
Municipal solid waste, average, Baseline scenario	Incineration with energy recovery in WtE plant (MSWI)	489	-441	48	(see below)		
	Landfill	617	0	617	(see below)		
Municipal solid waste, average, Projection 1+2	Incineration with energy recovery in WtE plant (MSWI)	492	-359	134	493	-399	94
	Landfill	617	0	617	618	0	618

* Baseline + Projection 1: 50%/50%; Projection 2: 10%/90%; Avoiding coal on an energy basis

Source: [Ecoinvent v.3.6], assessment and calculation by CE Delft

CO₂ factors – Transport

Transport emissions

- Transport of waste is not included in the CO₂ factors of waste treatment. Both the transporting distance as the transportation mode (modality) vary between Member States due to the different country sizes. Below graph shows the GHG emission of transport of 1 tonne of cargo for several modes of transport, at varying transportation distances. In terms of CO₂, per tonne of cargo, transport by a medium-sized truck (7,5 – 16 t) is most CO₂-intensive while transport by container ship is least CO₂-intensive.
- It can be seen that the impact of transport is relatively modest in comparison with the CO₂ factors per tonne of waste to the various treatment routes.

Transportation means:	Medium sized truck (7,5 - 16t), EURO 4/5 150 km distance	Large truck (16- 32 t), EURO 4/5 150 km distance	Unit
Impact on climate change; 20-year time horizon	33	26	kg CO ₂ eq/tonne
Impact on climate change; 100-year time horizon	32	24	kg CO ₂ eq/tonne

Source: analysis by CE Delft

Comparison of different transportation modes

- The graph below illustrates the additional CO₂ emission by transportation for a certain distance, with a certain transportation mode:
 - Transport of 1 tonne of waste over 500 km by a large truck (16 – 32 t) leads to additional emissions of 100 kg CO₂eq
 - Transport of 1 tonne of waste with a container ship over 1000 km leads to additional emissions of 10 kg CO₂eq

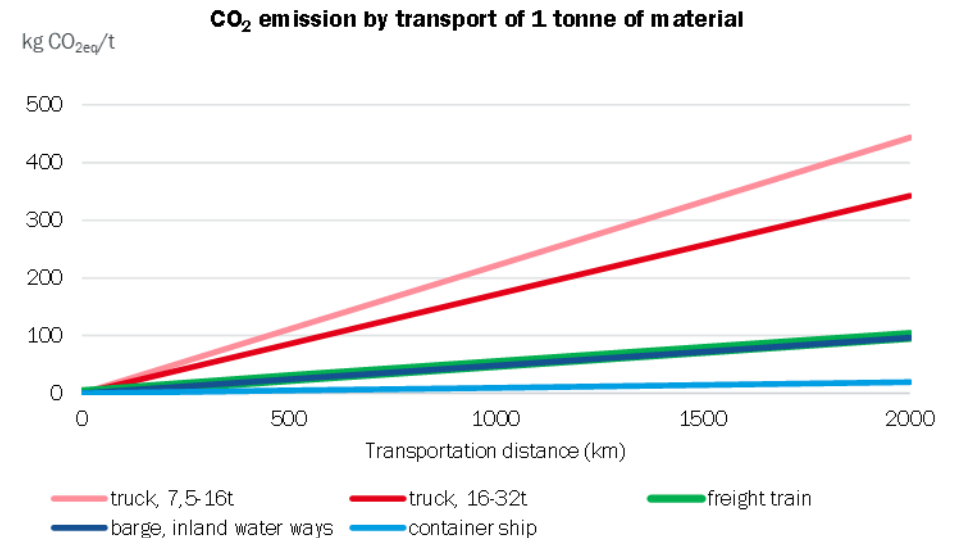

Annex A4

Bibliography

Bibliography

- ADEME 2017** L'Agence de l'Environnement et de la Maîtrise de l'Energie (ADEME) (2017): MODECOM 2017 - Campagne nationale de caractérisation des déchets ménagers et assimilés. Analyse des résultats.
- AEV 2019** Administration de l'environnement (AEV) (2019): Restabfallanalyse 2018/2019 im Großherzogtum Luxemburg. Endbericht. Ministère de l'Environnement, du Climat et du Développement durable. Available from: <https://environnement.public.lu/content/dam/environnement/actualites/2020/03/restabfallanalyse/20191203-Resstoffallanalyse-2018-2019.pdf>
- Agora & Sandbag 2020** Agora & Sandbag (2020): The European Power Sector in 2019: Up-to-Date Analysis on the Electricity Transition (Figure 1-3). Available from: https://static.agora-energiawende.de/fileadmin/Projekte/2019/Jahresauswertung_EU_2019/172_A-EW_EU-Annual-Report-2019_Web.pdf
- Avfall Sverige 2016** Avfall Sverige (2016): Vad slänger hushållen i soppsåsen? Nationell sammanställning av plockanalyser av hushållens mat- och restavfall. Rapport 2016:28.
- Baxter et al. 2014** Baxter, J.; Wahlstrom, M.; Castell-Rüdenhausen, M. zu; Fråne, A.; Stare, M.; Løkke, S.; Pizzol, M. (2014): Plastic value chains – Case: WEEE (Waste Electric and electronic equipment) in the Nordic region. Kopenhagen. . Available from: <https://www.diva-portal.org/smash/get/diva2:791245/FULLTEXT01.pdf>
- Bisinella et al. 2021** Bisinella, V., Hulgaard, T., Riber, C., Damgaard, A., & Christensen, T. H. (2021): Environmental assessment of carbon capture and storage (CCS) as a post-treatment technology in waste incineration. *Waste Management*, 128, 99–113. <https://doi.org/10.1016/j.wasman.2021.04.046>
- Blasenbauer et al. 2020** Blasenbauer, D., Huber, F., Lederer, J., Quina, M. J., Blanc-Biscarat, D., Bogush, A., Bontempi, E., Blondeau, J., Chimenos, J. M., Dahlbo, H., Fagerqvist, J., Giro-Paloma, J., Hjelm, O., Hyks, J., Keaney, J., Lupsea-Toader, M., O'Caollai, C. J., Orupöld, K., Pająk, T., ... Fellner, J. (2020): Legal situation and current practice of waste incineration bottom ash utilisation in Europe. *Waste Management*, 102, 868–883. <https://doi.org/10.1016/j.wasman.2019.11.031>
- BMK 2020** Bundesministerium für Klimaschutz, Umwelt, Energie, Mobilität, Innovation und Technologie (BMK) (2020): Auswertung der Restmüllzusammensetzung in Österreich 2018/2019. Ergebnisbericht. Wien.
- Boer et al. 2010** Boer, E. den, Jędrzak, A., Kowalski, Z., Kulczycka, J., & Szpadt, R. (2010): A review of municipal solid waste composition and quantities in Poland. *Waste Management*, 30(3), 369–377. <https://doi.org/10.1016/j.wasman.2009.09.018>
- Brouwer et al. 2019** Brouwer, M. T., Smeding, I. W., & Thoden van Velzen, E. U. (2019): Verkenning effect verschuiven meetpunt recycling kunststofverpakkingen. <https://doi.org/10.18174/474139>
- CE Delft 2021a** CE Delft (2021): Klimaatimpact van afvalverwerkroutes in Nederland. CO2-kentallen voor recyclen en verbranden voor 13 afvalstromen. (CO2 factors for waste treatment routes in The Netherlands.) Available from: <https://ce.nl/publicaties/klimaatimpact-van-afvalverwerkroutes-in-nederland-co2-kentallen-voor-recyclen-en-verbranden-voor-13-afvalstromen/>
- CE Delft 2021b** CE Delft (2021): Methodiek duurzaam aanbesteden afval Opgesplitst in een basismethodiek en een gedetailleerde methodiek update 2021. Available from: https://ce.nl/wp-content/uploads/2021/03/CE_Delft_200151_Methodiek_duurzaam_aanbesteden_afval_update_2021_DEF.pdf

Bibliography

- CE Delft 2020** CE Delft (2020): Aanbestedingsmethodiek groenafval. BVOR (Branchevereniging Organische Reststoffen).
- CE Delft 2019** CE Delft (2019): Verwerkingsscenario's Vlaams huishoudelijk afval en gelijkaardig bedrijfsafval 2020-2030. (Treatment routes of Flemish waste from households and companies 2020-2030.) OVAM, Mechelen, September 2019. Available from: <https://www.ovam.be/verwerkingsscenario's-vlaams-huishoudelijk-afval-en-gelijkaardig-bedrijfsafval-2020-2030>
- CE Delft 2018** CE Delft (2018): Screening LCA for CCU routes connected to CO2 Smart Grid. Available from: <https://ce.nl/publicaties/screening-lca-for-ccu-routes-connected-to-the-co2-smart-grid/>
- CE Delft 2011** CE Delft (2011): LCA: recycling van kunststof verpakkingsafval uit huishouden. (Recycling of plastic packaging waste from households – an LCA.) Available from: <https://ce.nl/publicaties/lca-recycling-van-kunststof-verpakkingsafval-uit-huishoudens/>
- CEWEP 2021** Confederation of European Waste-to-Energy Plants (CEWEP) (2021): Average Net Electrical and Thermal Efficiency of European WtE Plants. Analysis Provided by CEWEP.
- CTC 2018** Clean Technology Centre (CTC) (2018): Municipal Waste Characterisation. Non-Household Campaign. Final Report. Available from: https://www.epa.ie/publications/monitoring-assessment/waste/national-waste-statistics/Final_Report_NHWC.pdf
- DOLNÝ OHAJ n.d.** DOLNÝ OHAJ (n.d.): Triedenie komunálneho odpadu. <https://www.obecdolnyohaj.sk/samosprava/separovany-zber/triedenie-komunalneho-odpadu/?ftresult=triedenie+komunalneho+odpadu>
- EC 2020** European Commission (EC) (2020): SWD (2020) 176 final. Commission staff working document impact assessment. Part 2/2. Available from: https://eur-lex.europa.eu/resource.html?uri=cellar:749e04bb-f8c5-11ea-991b-01aa75ed71a1.0001.02/DOC_2&format=PDF
- EC 2016** European Commission (EC) (2016): Mapping and analyses of the current and future (2020 - 2030) heating/cooling fuel deployment (fossil/renewables). Available from: <https://ec.europa.eu/energy/sites/default/files/documents/mapping-hc-excecutesummary.pdf> (Figure 4)
- ECN 2019** European Compost Network e.V. (ECN) (2019): ECN Status Report. European Bio-Waste Management. Overview of Bio-Waste Collection, Treatment & Markets Across Europe.
- ECN 2017** European Compost Network e.V. (ECN) (2017): Country Report 2017. Germany.
- Ecoinvent v.3.6** Ecoinvent Version 3.6; Wernet, G., Bauer, C., Steubing, B., Reinhard, J., Moreno-Ruiz, E., and Weidema, B. (2016): The ecoinvent database version 3 (part I): Overview and methodology. The International Journal of Life Cycle Assessment, [online] 21(9), pp.1218–1230. Available from: <http://link.springer.com/10.1007/s11367-016-1087-8>
- Edjabou 2016** Edjabou, M. E. (2016): Composition of municipal solid waste in Denmark. PhD Thesis. DTU Environment. Department of Environmental Engineering. Technical University of Denmark. Lyngby.

Bibliography

- EKO-KOM 2019** EKO-KOM (2019): Skladba směsného komunálního odpadu z domácností ČR. EKO-KOM. Available from: <https://www.ekokom.cz/skladba-smesneho-komunalniho-odpadu-z-domacnosti-cr/>
- EMF 2017** Ellen McArthur Foundation (EMF) (2017): A New Textiles Economy: Redesigning Fashion's Future.
- EPA 2021** Understanding Global Warming Potentials, accessed 2021
<https://www.epa.gov/ghgemissions/understanding-global-warming-potentials>
- EUROSTAT 2010** EUROSTAT (2010): Guidance on classification of waste according to EWC-Stat categories. Supplement to the Manual for the Implementation of the Regulation (EC) No 2150/2002 on Waste Statistics. Version 2. Available from: <https://ec.europa.eu/eurostat/documents/342366/351806/Guidance-on-EWCStat-categories-2010.pdf/0e7cd3fc-c05c-47a7-818f-1c2421e55604>
- Global CCS Institute 2019** Global CCS Institute (2019): CORE Facilities database. Available from: <https://co2re.co/FacilityData>
- Hogg et al. 2016** Hogg, D. D., Vergunst, T., Elliott, T., Elliott, L., Corbin, M., & Norstein, H. (2016): Support to the Waste Targets Review. 135.
- Huisman et al. 2007** Huisman J, Magalini F, Kuehr R, Maurer C, Ogiłvoe S, Poll J, Delgado C, Artim E, Szlezak J, Stevels A (2007): Review of Directive 2002/96 on Waste Electrical and Electronic Equipment (WEEE). Final report.
- IEA 2020** International Energy Agency (IEA) (2020): CCUS in Power, IEA, Paris. Available from: <https://www.iea.org/reports/ccus-in-power>
- IEAGHG 2020** IEA Greenhouse Gas R&D Programme (IEAGHG) (2020): CCS on Waste to Energy. IEAGHG Technical Report 2020-06 December 2020. Available from: <https://www.club-co2.fr/files/2021/01/2020-06-CCS-on-Waste-to-Energy.pdf>
- Inglezakis et al. 2012** Inglezakis, V.; Dvorsak, S.; Varga, J.; Venetis, C.; Zorpas, A.; Ardeleanu, N.; Ilieva, L.; Samaras, P. (2012). Municipal Solid Waste Composition and Physicochemical Characteristics in Romania and Bulgaria. International Journal of Chemical and Environmental Engineering Systems. 3. 64-73.
- IPCC 2013** IPCC, 2013: Climate Change 2013: The Physical Science Basis. Contribution of Working Group I to the Fifth Assessment Report of the Intergovernmental Panel on Climate Change [Stocker, T.F., D. Qin, G.-K. Plattner, M. Tignor, S.K. Allen, J. Boschung, A. Nauels, Y. Xia, V. Bex and P.M. Midgley (eds.)]. Cambridge University Press, Cambridge, United Kingdom and New York, NY, USA, 1535 pp. Available from: <https://www.ipcc.ch/report/ar5/wg1/>
- IPCC 2019** IPCC (2019): 2019 Refinement to the 2006 IPCC Guidelines for National Greenhouse Gas Inventories. Task Force on National Greenhouse Gas Inventories. Available from: <https://www.ipcc-nggip.iges.or.jp/public/2019rf/index.html>
- IRENA & IEA-PVPS 2016** International Renewable Energy Agency (IRENA) & International Energy Agency Photovoltaic Power Systems (IEA-PVPS) (2016): End-of-Life Management: Solar Photovoltaic Panels. International Renewable Energy Agency and International Energy Agency Photovoltaic Power Systems. Abu Dhabi. Available from: http://www.irena.org/-/media/Files/IRENA/Agency/Publication/2016/IRENA_IEAPVPS_End-of-Life_Solar_PV_Panels_2016.pdf

Bibliography

- ISPRA 2020** L'istituto Superiore per la Protezione e la Ricerca Ambientale (ISPRA) (2020): Rapporto Rifiuti Urbani. Edizione 2020. Available from: https://www.isprambiente.gov.it/files2020/pubblicazioni/rapporti/rapportorifiutiurbani_ed-2020_n-331-1.pdf
- Kubule et al. 2019** Kubule, A.; Klavenieks, K.; Vesere, R.; Blumberga, D. (2019): Towards Efficient Waste Management in Latvia: An Empirical Assessment of Waste Composition. *Environmental and Climate Technologies*. 23. 114-130. 10.2478/rtuct-2019-0059.
- LEAP 2017** Laboratorio Energia e Ambiente Piacenza (LEAP) (2017): Trattamento e recupero delle ceneri pesanti da incenerimento. Available from: <https://www.utilitalia.it/dms/file/open/?16a10c7a-c142-4ad5-9133-14c45890611c>
- Liikanen et al. 2018** Liikanen, M.; Havukainen, J.; Grönman, K.; Horttanainen, M. (2018): Construction and Demolition Waste Streams from the Material Recovery Point of View: A Case Study of the South Karelia Region, Finland. 171–181. Conference Paper. Waste Management and the Environment IX. 17-19 September 2018. Seville, Spain <https://doi.org/10.2495/WM180161>
- Lindner & Schmitt 2018** Lindner C.; Schmitt J. (2018): Stoffstrombild Kunststoffe in Deutschland 2017: plastics material flow in Germany 2017. Conversio Market & Strategy GmbH; 2018.
- Marx et al. 2011** Marx, J., Schreiber, A., Zapp, P., Haines, M., Hake, J.-Fr., & Gale, J. (2011): Environmental evaluation of CCS using Life Cycle Assessment – A synthesis report. *Energy Procedia*, 4, 2448–2456. <https://doi.org/10.1016/j.egypro.2011.02.139>
- MZOE 2018** Ministarstvo zaštite okoliša i energetike (MZOE) (2018): Gospodarenje otpadom u Republici Hrvatskoj u 2018. HGK, Zagreb, 2. svibnja 2018. Republika Hrvatska. Available from: <https://www.hgk.hr/documents/pgo-prezentacija-hgk-burza-otpada-2520185aeb13c483058.pdf>
- Merlin & Vogt 2020** Merlin, C. B.; Vogt, R. (2020): Life cycle assessment of waste tyre treatments: Material recycling vs. co-incineration in cement kilns. Available from: https://www.genan.dk/wp-content/uploads/2020/10/LCA-report_Genan_Executive-Summary_2020.pdf
- Mueller 2014** Mueller, A. (2014): Tools for Management of Construction and Demolition Waste. Conference Paper. EurAsia Waste Management Symposium, 28-30 April 2014, YTU 2010 Congress Center, Istanbul/Turkey.
- Müller & Widmer 2010** Müller, E.; Widmer, P. (2010): Materialflüsse der elektrischen und elektronischen Geräte in der Schweiz. Bern. Available from: https://www.bafu.admin.ch/dam/bafu/de/dokumente/abfall/fachinfo-daten/materialfluesse_vonelektrischenundelektronischengerateneindersch.pdf.download.pdf/materialfluesse_vonelektrischenundelektronischengerateneindersch.pdf
- OVAM 2015** Openbare Vlaamse Afvalstoffenmaatschappij (OVAM) (2015): Sorteeraanlyse-onderzoek huisvuil 2013-2014. Mechelen. Available from: <https://ovam.be/sites/default/files/atoms/files/Sorteeranalyse-onderzoek-huisvuil-2013-2014-def.pdf>

Bibliography

- PlasticsEurope 2020** PlasticsEurope (2020): Plastics – the Facts 2020. An analysis of European plastics production, demand and waste data. Brussels.
- Prognos 2008** Prognos, ifeu, INFU (2008): Resource savings and CO₂ reduction potential in waste management in Europe and the possible contribution to the CO₂ reduction target in 2020
- Prognos 2018** Prognos (2018): Studie zur Verwertung von Altfahrzeugen. Düsseldorf, 2018.
- Raadal & Modahl 2021** Raadal, H. L.; Modahl, I. S. (2021): Life Cycle Assessment of CCS (carbon capture and storage) and CCU (carbon capture and utilization). Available from: https://norsus.no/wp-content/uploads/LCA-of-CCS-and-CCU_OR-28.21_final-report-1.pdf
- Rijkswaterstaat 2021** Rijkswaterstaat (2021): RWS Informatie: Samenstelling van het huishoudelijk restafval, sorteeranalyses 2020. Gemiddelde driejaarlijkse samenstelling 2019. RWS Informatie. Rijkswaterstaat, Utrecht. Available from: https://puc.overheid.nl/rijkswaterstaat/doc/PUC_633943_31/#
- Rijkswaterstaat 2020** Rijkswaterstaat (2020): Afvalverwerking in Nederland, gegevens 2018. (Waste treatment in The Netherlands 2018.) Ministerie van I&W, Den Haag. Available from: <https://www.afvalcirculair.nl/onderwerpen/linkportaal/publicaties/downloads/downloads-0/afvalverwerking-nederland-gegevens-2018/>
- Stichting RIONED & STOWA 2015** Stichting RIONED & STOWA (2015): Huishoudelijke voedselresten in de afvalwaterketen. Levenscyclusanalyse van de verwerking van groente- en fruitafval en afvalwater. Available from: <https://www.stowa.nl/sites/default/files/assets/PUBLICATIES/Publicaties%202015/STOWA%202015-07.pdf>
- RVO 2020** Rijksdienst voor Ondernemend Nederland (RVO) (2020): List of emission factors per energy carrier. Nederlandse lijst van energiedragers en standaard CO₂ emissiefactoren, versie januari 2020. Available from: <https://www.rvo.nl/sites/default/files/2020/03/Nederlandse-energiedragerlijst-versie-januari-2020.pdf>
- Salhofer 2017** Salhofer, S. (2017): E-Waste Collection and Treatment Options: A Comparison of Approaches in Europe, China and Vietnam. In: Maletz R., Dornack C., Ziyang L. (eds) Source Separation and Recycling. The Handbook of Environmental Chemistry, vol 63. Springer, Cham. https://doi.org/10.1007/698_2017_36
- Salhofer et al. 2012** Salhofer, S.; Spitzbart, M.; Maurer, K. (2012): Recycling of flat screens as a new challenge in WEEE recycling. Waste and Resource Management 165 (1), pp. 37-43.
- Salhofer & Spitzbart 2009** Salhofer, S.; Spitzbart, M. (2009): Modelling of mechanical treatment of WEEE. In: Proceedings of the 3rd BOKU waste conference, Vienna, pp 143–150.
- Sellin et al. 2016** Sellin, G.; Fröhlich, H.; Rasenack, K. (2016): InAccess – Rückgewinnung von Indium durch effizientes Recycling von LCD-Bildschirmen (RuR 2016). Available from: https://www.vivis.de/wp-content/uploads/RuR9/2016_RuR_163-176_Sellin
- Stichnoth & Azapagica 2012** Stichnoth, H.; Azapagica, A. (2012): Life cycle assessment of recycling PVC window frames. Resources, Conservation and Recycling 71 (2013), pp. 40-47. Available from: https://www.academia.edu/29046875/Life_cycle_assessment_of_recycling_PVC_window_frames

Bibliography

- Šyc et al. 2020** Šyc, M., Simon, F. G., Hykš, J., Braga, R., Biganzoli, L., Costa, G., Funari, V., & Grosso, M. (2020): Metal recovery from incineration bottom ash: State-of-the-art and recent developments. *Journal of Hazardous Materials*, 393, 122433. <https://doi.org/10.1016/j.jhazmat.2020.122433>
- UBA 2020** Umweltbundesamt (UBA) (2020): Vergleichende Analyse von Siedlungsrestabfällen aus repräsentativen Regionen in Deutschland zur Bestimmung des Anteils an Problemstoffen und verwertbaren Materialien. Abschlussbericht. Available from: https://www.umweltbundesamt.de/sites/default/files/medien/479/publikationen/texte_113-2020_analyse_von_siedlungsrestabfaellen_abschlussbericht.pdf
- UBA 2018** Umweltbundesamt (UBA) (2018): Behandlung von Elektroaltgeräten (EAG) unter Ressourcen- und Schadstoffaspekten. Abschlussbericht. Available from: https://www.umweltbundesamt.de/sites/default/files/medien/1410/publikationen/2018-04-12_texte_31-2018_behandlung_eag.pdf
- UBA 2015** Umweltbundesamt (UBA) (2015): Ermittlung der Emissionssituation bei der Verwertung von Bioabfällen. Dessau-Roßlau. Available from: https://www.umweltbundesamt.de/sites/default/files/medien/378/publikationen/texte_39_2015_ermittlung_der_emissionssituation_bei_der_verwertung_von_bioabfaellen.pdf
- UNFCCC 2021** Global Warming Potentials (IPCC Second Assessment Report), accessed 2021 <https://unfccc.int/process/transparency-and-reporting/greenhouse-gas-data/greenhouse-gas-data-unfccc/global-warming-potentials>
- Utilitalia 2020** Utilitalia (2020): Managing and recovering bioplastics. Position Paper.
- Wang et al. 2020** Wang, Y., Levis, J. W., & Barlaz, M. A. (2020): An Assessment of the Dynamic Global Warming Impact Associated with Long-Term Emissions from Landfills. *Environmental Science & Technology*, 54(3), 1304–1313. <https://doi.org/10.1021/acs.est.9b04066>
- WRAP 2020** Waste and Resources Action Programme (WRAP) (2020): Compositional analysis of Local Authority collected and non-Local Authority collected non-household municipal waste. England.
- WRAP 2020** Waste and Resources Action Programme (WRAP) (2020): Synthesis of Household Food Waste Compositional Data 2018. Banbury.
- WRAP 2019** Waste and Resources Action Programme (WRAP) (2019): National municipal commercial waste composition, England 2017.

Bibliography – Legal Documents

- 2018/850/EU** Directive (EU) 2018/850 of the European Parliament and of the Council of 30 May 2018 amending Directive 1999/31/EC on the landfill of waste (OJ L 150, 14.06.2018, p. 100-108).
- 2018/851/EU** Directive (EU) 2018/851 of the European Parliament and of the Council of 30 May 2018 amending Directive 2008/98/EC on waste (OJ L 150, 14.06.2018, p. 109-140).
- 2018/852/EU** Directive (EU) 2018/852 of the European Parliament and of the Council of 30 May 2018 amending Directive 94/62/EC on packaging and packaging waste (OJ L 150, 14.06.2018, p. 141-154).
- 2012/19/EU** Directive 2012/19/EU of the European Parliament and of the Council of 4 July 2012 on waste electrical and electronic equipment (WEEE) (OJ L 197, 24.7.2012, p. 38–71)
- 2008/98/EC** Directive 2008/98/EC of the European Parliament and of the Council of 19 November 2008 on waste (OJ L 312, 22.11.2008, p. 3–30)
- 2000/53/EC** Directive 2000/53/EC of the European Parliament and of the Council of 18 September 2000 on end-of life vehicles (OJ L 269, 21.10.2000, p. 34–43)
- 849/2010/EU** Commission Regulation (EU) No 849/2010 of 27 September 2010 amending Regulation (EC) No 2150/2002 of the European Parliament and of the Council on waste statistics. Available under: <https://eur-lex.europa.eu/LexUriServ/LexUriServ.do?uri=OJ:L:2010:253:0002:0041:EN:PDF>
- 2011/753/EU** Commission Decision 2011/753/EU of 18 November 2011 establishing rules and calculation methods for verifying compliance with the targets set in Article 11(2) of Directive 2008/98/EC of the European Parliament and of the Council (notified under document C(2011) 8165)

We provide orientation.

Prognos AG – European Centre
for Economic Research and Strategy Advise

